



# A Landowner's Guide to Wildlife Friendly Fences:

## How to Build Fence with Wildlife in Mind



donaldmjones.com



Montana Fish,  
Wildlife & Parks



FWP

### **Acknowledgements**

Many land and wildlife specialists offered their insights to this guide. Joe Weigand, Montana Fish, Wildlife and Parks Landowner/Wildlife Resource Specialist, provided funding and guidance for the project, as well as expertise from testing various designs with landowners. Bryce Andrews conducted interviews and wrote the profiles detailing landowner and ranch manager experiences. FWP biologist Jay Kolbe provided fence specifications, photos and other invaluable contributions to the project. Ralph Burchenal, John Kountz, Marina Smith, Wayne Ternes, Juanita Vero, the Anaconda Gun Club and the Rocky Mountain Elk Foundation partnered with Montana Fish, Wildlife and Parks to test fence designs in various livestock and wildlife situations and provided invaluable insights and suggestions. Many biologists and resource professionals around the U.S. provided references and insights from their experience via email and listservs – thank you all.

### **Author**

Christine Paige, Ravenworks Ecology, Stevensville, MT. [chrispaige@gmail.com](mailto:chrispaige@gmail.com).

### **Graphic Design**

Seiler Design & Advertising, Missoula, MT. [nadesign@montana.com](mailto:nadesign@montana.com).

### **Illustrations**

E.R Jenne Illustration, Missoula, MT. [edjenne@earthlink.net](mailto:edjenne@earthlink.net).

### **Citation**

Paige, C. 2008. A Landowner's Guide to Wildlife Friendly Fences. Landowner/Wildlife Resource Program, Montana Fish, Wildlife and Parks, Helena, MT. 44 pp.



donaldmjones.com

**Wildlife and Fences** ..... 2

**Problem Fences** ..... 3

**Wildlife Friendly Fences** ..... 6

    Getting Started ..... 6

    Fence and Crossing Placement ..... 6

**Friendly Designs** ..... 8

    Visibility ..... 9

    Sites with Low or Seasonal Livestock Use ..... 11

    Sites with High or Continuous Livestock Use ..... 17

    Openings, Crossings and Passes ..... 23

**Remedies for Existing Fences** ..... 32

**Fence Alternatives** ..... 33

**If You Must Exclude** ..... 35

**Getting Help** ..... 40



## Wildlife and Fences

***Fences crisscross Montana landscapes like countless strands of a spider's web.***

Barbed-wire, woven-wire, jackleg and other fences define and divide ranches and farms, outline property boundaries, enclose pastures and rangelands, and run for miles along highway and road corridors. Yet fences can be barriers and traps for wildlife, from big game animals to birds, causing injury and unnecessary fatalities. Animal damage to fences is also costly and frustrating for landowners.

We share our lands with a rich and abundant array of wildlife in Montana – wildlife that must travel across landscapes to find food, shelter and water for survival. Too often, animals and birds are injured or killed when they collide with fences or get tangled in wires. Most people would prevent these needless deaths if only they knew how.

***Not all fences are problem fences. By tailoring your fence design and placement, you can prevent injury to wild animals and lessen wildlife damage to your fence. Many of these methods are low-cost or can save you money in the long-run by reducing the need for fence repair.***



FWP



Christine Paige



**Deer, elk, moose, mountain sheep, and pronghorn** are all capable of jumping fences, but barbed-wire can snag animals and tangle legs, especially if wires are loose or spaced too closely together. If animals can't pull free, they die a slow and desperate death. Even when animals do clear fences, or crawl through or under the strands, they often bear countless scars from wire barbs.

Some fences, especially woven-wire, can be a complete barrier to fawns and calves even if adults can still jump over. Separated from their mothers, the youngsters curl up and die of starvation, stranded and unable to follow the herd. Woven wire can also block animals, such as bears and bobcats, that are unable to leap fences and are too large to slip through.

If woven wire is topped with one or more strands of barbed-wire, the fence becomes a complete barrier, especially for fawns, calves, pronghorn and other animals that are incapable or unwilling to jump over such a fence. Animals trying to leap a woven-wire/barbed-wire fence are even more likely to tangle a leg between the top barbed-wire and the stiff woven wire.

## **What kinds of fence cause problems for wildlife?**

Fences that:

- are too high to jump;
- are too low to crawl under;
- have loose wires;
- have wires spaced too closely together;
- are difficult for fleeing animals or birds to see;
- create a complete barrier.



Christine Paige

Above: A fence mess – adjacent landowners erected two fences, creating a nightmare tangle for wildlife.



Christine Paige



Christine Paige

Top: A panicked deer looks for a way through a barbed-wire fence.

Left: Pronghorn find it almost impossible to cross woven wire fences topped with barbed wire.

# Problem Fences

Birds, too, collide with fences, breaking wings, impaling themselves on barbs, and tangling in wires. Large, low-flying birds such as ducks, geese, cranes, swans, grouse, hawks and owls are especially vulnerable. Waterfowl fly into fences that run near or across waterways, and low-flying hawks and owls may careen into fences when swooping in on prey.



Mark Gocke

Swans and other waterfowl can be victims of fences strung across or near waterways.

Jackleg or buck and rail fences are sometimes considered wildlife friendly, but they are usually built too high, too wide and with rails placed too closely together for animals to cross or crawl through. The three-dimensional jackleg design is especially hard to leap over, and if jackleg is combined with woven or barbed-wire or placed on steep terrain, it presents an almost complete barrier to ungulates and other large animals. Jackleg fence also requires high maintenance – the posts and rails can rot and collapse under snow loads and winds.



Doug Wood

This peregrine falcon died when it collided with a fence while diving on killdeer. Many birds are vulnerable to fence collisions.



Chris Mayne

Above: After crossing a highway, a black bear desperately searches for a way through a woven-wire fence, finally climbing a power pole to leap over.



Steve Pimm

Left: This badly tangled pronghorn was fortunately freed by the photographer, who was able to clip the wires.



## Hard Numbers

Recently, researchers at Utah State University completed a study of wildlife mortality along more than 600 miles of fences in the rangelands of northeastern Utah and northwestern Colorado (Harrington 2005, Harrington and Conover 2006). By repeatedly driving and walking fencelines over two seasons, they tallied the number of mule deer, pronghorn and elk carcasses they found caught in fences and lying next to fences. They also studied which fence types caused the most problems. Here are their key findings:

### Snared and Entangled

- On average, one ungulate per year was found tangled for every 2.5 miles of fence.
- Most animals (69% of juveniles and 77% of adults) died by getting caught in the top two wires while trying to jump a fence.

- Juveniles are eight times more likely to die in fences than adults.
- Mortalities peaked during August, when fawns are weaned.
- Woven-wire fence topped with a single strand of barbed-wire was the most lethal fence type, as it more easily snared and tangled legs between the barbed-wire and rigid woven-wire.
- 70% of all mortalities were on fences higher than 40”.

### Blocked and Stranded

- Where ungulates were found dead next to, but not in fences, on average one ungulate per year died for every 1.2 miles of fence.
- 90% of these carcasses found near fences were fawns lying in a curled position – probably separated from their mothers when they could not cross.
- Most of these indirect mortalities were found next to woven-wire fences.



Randy Gazda



Bryce Andrews



Rory Karhu

Above: Elk, deer and other ungulates can suffer a terrible death if their legs tangle in fences. Landowners have the sad and frustrating job of clearing out carcasses and repairing wildlife damage to their fences.

Left: Antlered animals can become fatally tangled in poly rope fence and loose barbed wire. Maintaining fence tension and using high-tensile wire for electric fences prevents such tragedies.



# Wildlife Friendly Fences

## When you design your fence, consider:

- purpose of the fence
- topography – hills, gullies, streams and wetlands
- species of wildlife present
- daily or seasonal wildlife movements in the area
- presence of water, food and cover for wildlife
- presence of young animals

## Getting Started

**The best situation for wildlife is open habitat with no fences at all.** Where fence is necessary, less fence is better. To get started, consider your needs and create a plan.

This guide will help you with designs that are wildlife friendly. You can tailor any of these designs to your specific needs.

**But first consider these questions:**

**1. What is the purpose of the fence? Do you need to mark a boundary? Deter trespass?**

**Enclose or exclude livestock? If your fence is for livestock, what kind, in what seasons, and for how long? Your purpose should determine your fence design and placement.**

**2. What is the topography? Are you fencing on hills, in rocky country where posts cannot be driven, or near or across streams or wetlands? Can you design your fence to avoid topography traps for wildlife?**

**3. Which wildlife species are in your area and may need to negotiate the fence?**

**4. What are the daily or seasonal wildlife movements in the area? Do animals calve or nest nearby?**

## Fence and Crossing Placement

**The placement of fences is just as important as the type of fence used.** Fencing need not restrict wildlife movement everywhere on your property. Wherever possible, design your fence to provide wildlife free travel to important habitats and corridors, as well as access to water. Wetlands and riparian habitats are especially important for all wildlife.

Watch for daily and seasonal wildlife movement patterns and look for trails.

Use special purpose fencing only in the areas needed, such as livestock pastures, haystacks, gardens, orchards, yards, play areas, or kennels. Design property boundary fences so wildlife can easily cross, or with

gaps or lay-down sections for wildlife passage wherever livestock are not present.

Work with your land's topography. Swales, gullies, ridges and stream corridors can funnel wildlife through an area – keep these open to allow wildlife passage and avoid topography traps.

### SLOPE INCREASES BARRIER

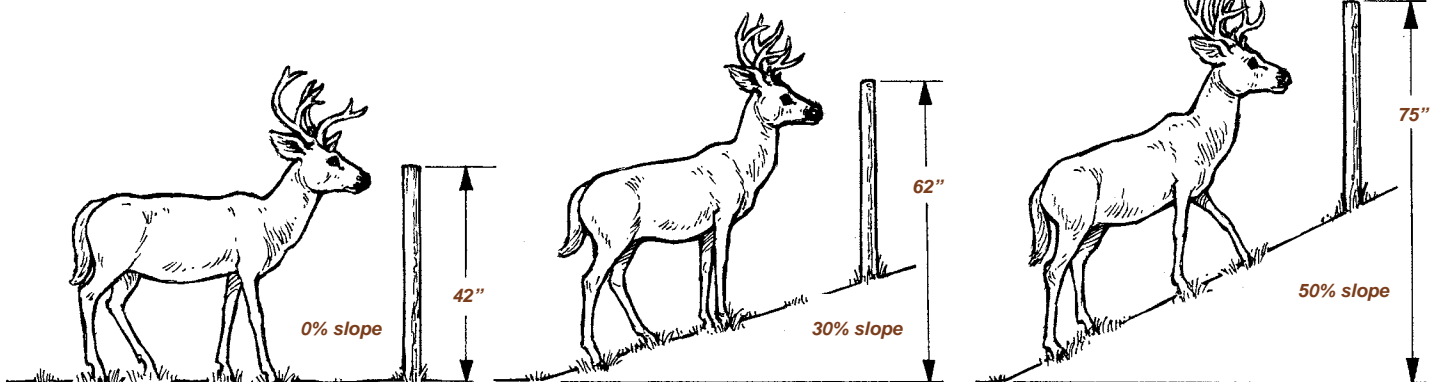



# Wildlife Friendly Fences



Place crossings, jumps, open gates and other wildlife openings in appropriate locations. Deer, elk and pronghorn are more likely to use openings at fence corners than in the middle of a fence run, unless there is cover, habitat or natural corridors or trails to attract them through. Intermittent openings should be placed where animals naturally travel: in riparian corridors, along gullies and ridges, and on existing game trails.

***A fence of any height is more difficult to cross when placed across a steep slope.*** As ground slope increases, the distance an animal must jump to clear the fence increases considerably (See illustration at left). For instance, a 42" fence may be passable on level ground, but a slope of only 10% increases the effective fence height to 48.6"; a slope of 30% increases effective height to 62", and on a 50% slope animals encounter an obstacle 75" high. Fences on steep slopes become nearly impossible for animals to jump without injury.

Tailor your fences to specific needs and allow wildlife access to water, important habitats, and travel corridors.

- Look for wildlife trails and watch for seasonal patterns.
- Provide wildlife access to riparian habitats, water holes and other high quality habitats.
- Provide passage along swales, gullies, ridges and stream corridors.
- Use the appropriate fence design for each activity.
- On slopes and in natural travel corridors, plan for wildlife crossings.



## Friendly Designs

**The ideal wildlife friendly fence** should (1) allow relatively free passage for animals to jump over and crawl under, and (2) be highly visible for both ungulates and birds. You can combine or tailor many of the ideas presented here for your specific situation.

Fences should be low enough for adult animals to jump, preferably 40" or less, and the top two wires should be no less than 12" apart. Deer and elk easily tangle their back legs if the top wires are closer together. The bottom wire or rail should be high enough for pronghorn, calves and fawns to crawl under, at least 18" from the ground. Increasing visibility using a top rail, high-visibility wire, flagging or other visual markers can help ungulates and birds, such as hawks, owls and swans, better navigate fences.

### **Wildlife Friendly Ideal**

Wildlife friendly fences should be low enough for adult animals to jump, high enough for animals to crawl under, and minimize the chance of tangling. Montana Fish, Wildlife and Parks (FWP) recommends:

- A top wire or rail preferably no more than 40" above the ground, and absolutely no more than 42";
- At least 12" between the top two wires;
- At least 18" between the bottom wire or rail and the ground;
- Smooth wire or rail for the top, smooth wire on bottom.
- No vertical stays;
- Posts at 16.5-foot intervals;
- Gates, drop-downs, or other passages where wildlife concentrate and cross.

Using smooth wire – barbless wire, high-visibility tape or braid, or high-tensile electric wire – for the top and bottom strands will prevent snagging and injuries. In wildlife migration areas, drop-down fence, lay-down fence or crossings can be used for seasonal wildlife passage.

### **IDEAL WILDLIFE FRIENDLY FENCE**

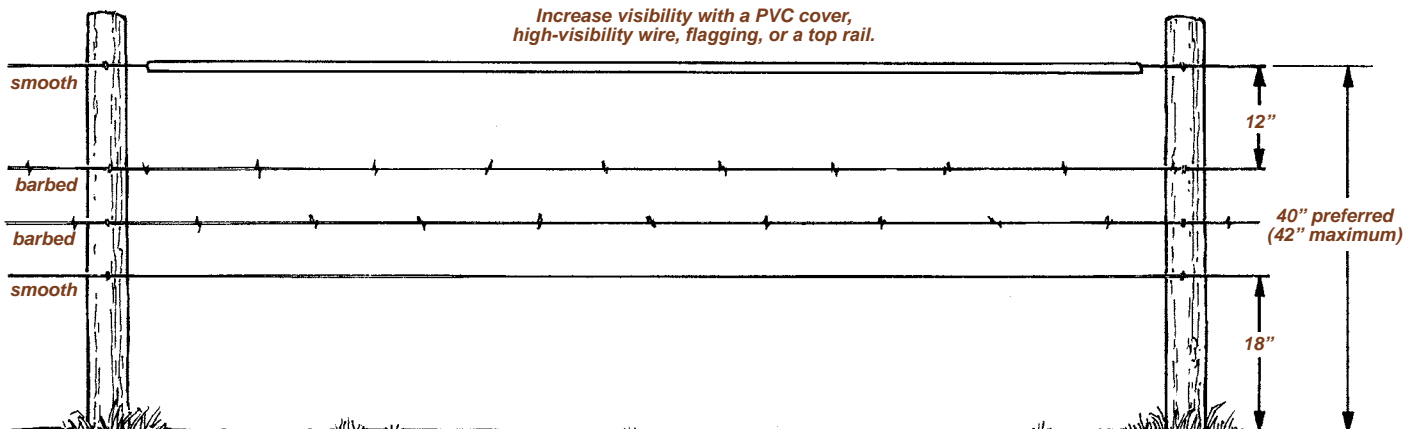

The friendliest fences are very visible and allow wild animals to easily jump over or slip under the wires or rails.



## Visibility

The best way to prevent a frightened deer or low-flying swan or grouse from colliding with a fence is to make it highly visible. One solution is a top rail, however heavy snow build-up along the rail can sometimes deter elk and deer from crossing, so a rounded rail that will shed snow more easily is preferable.

### HIGH VISIBILITY FENCE

For wire fences, a less expensive alternative is to slip sections of small diameter PVC pipe over the top strand. High-visibility wire is also available in many forms – tape, braid and polymer-coated wire – many of which can be electrified if needed. White wire is the most visible to wildlife.



FWP

The least expensive solution is to simply hang flagging, or other materials along the top, although many materials can fade or be lost and need regular replacement.

High visibility helps wildlife negotiate fences. It is especially important in grasslands and near creeks and wetlands to protect low-flying birds, such as grouse, owls and swans. PVC pipe, flagging, and white wire or tape all help wildlife see fences.



Jay Kolbe



## Visibility (CONTINUED)

Another relatively inexpensive alternative is offered by the Sutton Avian Research Center in Oklahoma using “undersill” or trim strips of white vinyl siding cut into 3” pieces. The undersill siding strips have a lip that can be snapped onto barbed-wire fence, and the vinyl strips can be easily cut with tin snips or a miter saw. The siding pieces are lightweight and durable, and a long run of fence can be marked quickly and easily.



Christine Paige

### Durable Markers for Wire Fence

- Several 12’ strips of “undersill” or trim strips of white vinyl siding, available at home hardware centers.
- Cut strips to 3” lengths. Use tin snips for small projects, or use a 10” miter saw with a 200-tooth blade to cut up to eight pieces at a time for larger projects.
- One 12’ siding strip yields 48 pieces.
- Snap pieces onto top and middle wires: at least four pieces on the top wire per fence section, and three pieces on the middle wire per section.



Christine Paige



Christine Paige

Durable and lightweight fence markers can be cut from strips of vinyl siding trim. The trim strip has a lip that easily snaps onto fence wires.

### DURABLE MARKERS ON WIRE FENCE

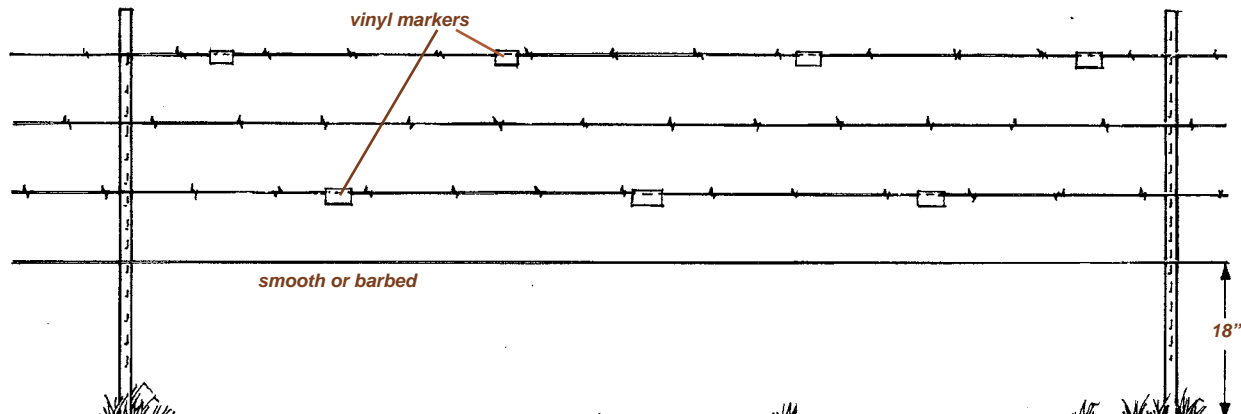



**Sites with Low or Seasonal Livestock Use**

Not all situations require a five-strand barbed-wire or woven-wire fence. Smooth wire fence, various types of post and rail fences, and temporary or moveable electric fences can be used for seasonal pastures, horse pastures and many other situations with low or intermittent livestock use.

**3-STRAND SMOOTH WIRE FENCE**

Use 3 strands of smooth (barbless) wire. High-tensile wire is effective for light livestock control.

- Top wire 40 to 42" high;
- Center wire 30" above the ground;
- Bottom wire 18" above the ground;
- Preferably, no vertical stays;
- Wood or steel posts at 16.5-foot intervals.



At the Blue-eyed Nellie WMA near Anaconda, the Anaconda Gun Club, local landowner Wayne Ternes, and FWP partnered to install a bighorn-sheep-friendly fence. Replacing old four- and five-strand barbed-wire, the new fences are three-strand smooth wire with a 39" top wire and 16" bottom wire. Bighorn sheep now readily hop over and duck under the fences.

Christine Paige

Christine Paige

**3-STRAND SMOOTH WIRE FENCE**

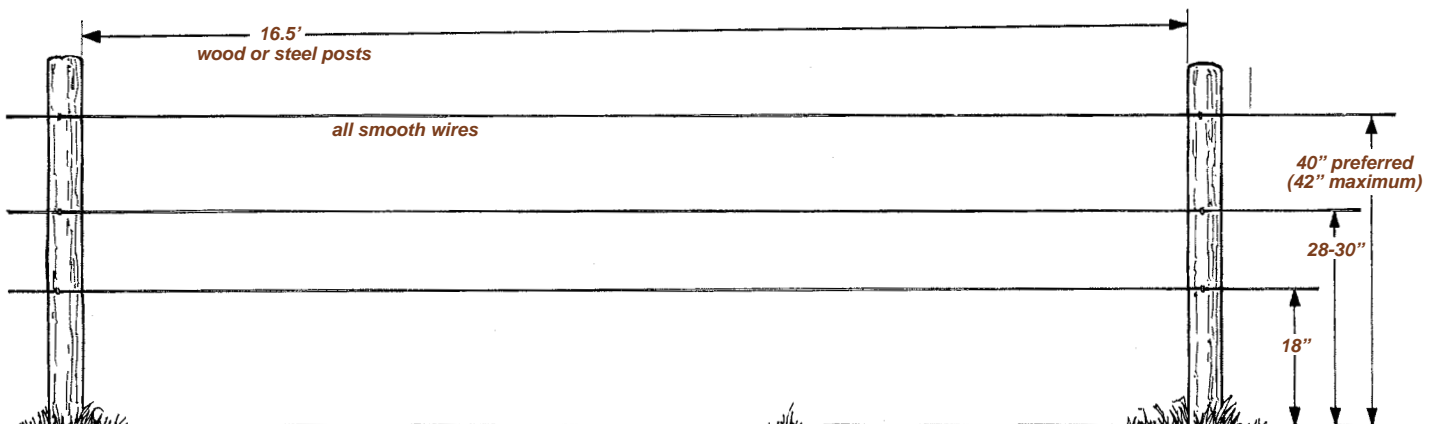



## Friendly Designs

### SEASONAL ELECTRIC WIRE FENCE

A flexible electric fence that allows passage for elk and other ungulates can still be effective for livestock, particularly horses broken to electric fence. It can be laid down seasonally to allow free wildlife passage. This fence is useful for keeping stock out of sensitive habitats or for short-duration grazing where permanent fencing isn't desired.

- Pre-drill 72" x 1" heavy fiberglass posts;
- Drive posts 24" into the ground at a 32-foot spacing

(a t-post pounder can be used if ground is soft);

- Use treated wooden posts for bracing at ends and center;
- Place a top wire of conductive high-visibility tape, braided wire or polymer-covered wire no higher than 42" height, electrically charged (medium-tensile 12-gauge plastic-coated wire is satisfactory).
- Place a second grounded strand of high-tensile wire at 30";
- Attach strands to fiberglass posts with wire clips that can be removed when fence is laid down;

- Use insulators for attaching hot top wire to wooden posts; grounded wire can be stapled or clipped directly to wooden posts.
- Use a solar electric energizer (size and placement depends on the run length of fence).

To work properly, this fence needs to flex as elk and other animals pass over it. Install as few rigid post supports as possible, and use the minimum recommended wire tension. Placing the energizer toward the middle of the fence will afford the greatest electrical efficiency.



Jay Kolbe

This 2-wire seasonal power fence can be used where stock are broken to electric fence. Wooden posts brace the ends. The fiberglass posts can be laid down when the fence is not in use.



Jay Kolbe



## Collaboration in the Blackfoot

**“Zero maintenance – it’s been amazing,”** says Juanita Vero of her new stretch of electric fence. Juanita, the fifth generation owner and manager of the E Bar L guest ranch in the Big Blackfoot Valley, has fixed her share of damaged fence. On the E Bar L, eighty head of horses share 4,000 acres of range with large numbers of deer and elk.

The vast majority of fences on the property are built with three or four barbed-wires hung from steel posts. Though these designs worked well on some parts of the ranch, they often failed when built across elk migration corridors. One particularly troublesome stretch of fence ran for a



Juanita Vero

***When I asked my 91-year-old grandfather if the fence project was a success, he quipped, “We wouldn’t do it if it wasn’t gonna work.”***

– Juanita Vero

ground wire, hung at 40”, is standard 12.5 gauge high-tensile steel.

The new fence works well. “Elk go right through it,” Juanita says. “When nobody is putting pressure on them, even the big bulls go under with no problem.” It holds their herd of horses well, too, although Juanita remains uncertain of whether the fence would adequately contain other types of livestock.

The Veros have experimented successfully on other parts of the ranch. They use temporary electric fence to divide pastures into smaller units, allowing them to better control the way their herd grazes. Because this polywire fence is a single strand design, it is highly permeable to wildlife.

Although most fence on the property remains barbed-wire, and the cost of replacing it with electric fence is high enough to be prohibitive, Juanita is upbeat about the potential for future innovation: “The best thing of all is that we have good agency people like Jay to work with, and a history of collaborative conservation in the Blackfoot Valley to build on.”

– Bryce Andrews



Juanita Vero

half mile along one edge of an irrigated hay pasture. Elk crossed the fence on their daily circuit between the Blackfoot River and a stand of timber, frequently causing damage. The Veros were ready for an innovative approach to fencing, and they sought the help of Jay Kolbe, Montana Fish, Wildlife and Parks Biologist, to help design and fund the project.

Under an agreement to evaluate the design, and splitting costs and labor, FWP and the Veros built a two-wire electrified fence on 1” diameter fiberglass posts spaced approximately 32’ apart. The top wire, hung 48” off the ground, is a high-visibility, plastic-sheathed, conductive wire designed especially for horses. The lower



## Friendly Designs

### MOVEABLE ELECTRIC WIRE FENCE

A moveable electric fence can be used for short-duration grazing, to keep stock out of sensitive areas such as wetlands, or for other situations where livestock need to be temporarily controlled. This fence works well for stock that have been previously broken to electric fences.

The design can be tailored to your situation, but a simple fence can be constructed using high visibility tape or “turbo wire” and fiberglass posts or plastic-insulated steel posts. A moveable fence can use either a single hot wire (when there is sufficient moisture for an adequate ground) or two wires, the top one hot, the lower wire grounded. Moveable posts on the market include designs with hooked or pigtail tops for quickly stringing wire, and a tread-in foot. These can be rapidly set up and moved as needed.

- Use 40” to 42” fiberglass or plastic-insulated steel posts, designed with hooks or loops for wire and tread-in spikes at the foot;
- Place one to two strands of high-visibility tape or polymer-covered turbo wire. If two wires, the top should be hot, the lower wire grounded. Top wire should be no higher than 42”; lower wire no lower than 18”;
- Use a solar electric energizer (size and placement depends on the run length of fence).



Christine Paige

A temporary electric fence can be used to keep stock out of sensitive areas and is easily negotiated by most wildlife.

### Tips on Electric Fences

Most electric fence problems are caused by poor grounding. Follow the manufacturer’s specifications for grounding the energizer and fence for your fence type and conditions. The number of ground rods needed may vary; a maximum reading of 0.2kv on a volt meter in dry conditions indicates an adequate ground. Wooden and steel fence posts require insulators for attaching hot wires; ground wires can be stapled or clipped on directly. Fiberglass and plastic line posts do not need insulators, but do require special clips for attaching wires. Check the fence regularly to be sure it is charged.



Seth Wilson





## POST AND RAIL FENCE

A post and rail fence is highly visible to wildlife and can be constructed for situations with or without livestock. Rail fences can either use a top rail with wires below, or two to three rails total. A two-rail fence is preferable to a three-rail fence for wildlife. Unless the fence is quite low, use rounded poles for the top rail, rather than a square or split-rail, to prevent too much snow build-up in winter, which can deter elk and deer. Also, unless the fence is easily jumped and there is ample clearance underneath, boards or planks are not recommended as these can create a visual barrier.



Christine Paige

- Use pressure-treated 6' to 8' posts, spaced 10' to 14' apart.
  - Use pressure-treated poles for top rail, placed no more than 40" above the ground.
  - Place smooth lower wires at 18" and 28" above the ground.
- Second wire should be at least 12" below top rail.
- OR place pressure-treated poles for lower rails, the bottom rail placed with at least 18" clearance from the ground.

## POST AND RAIL FENCE

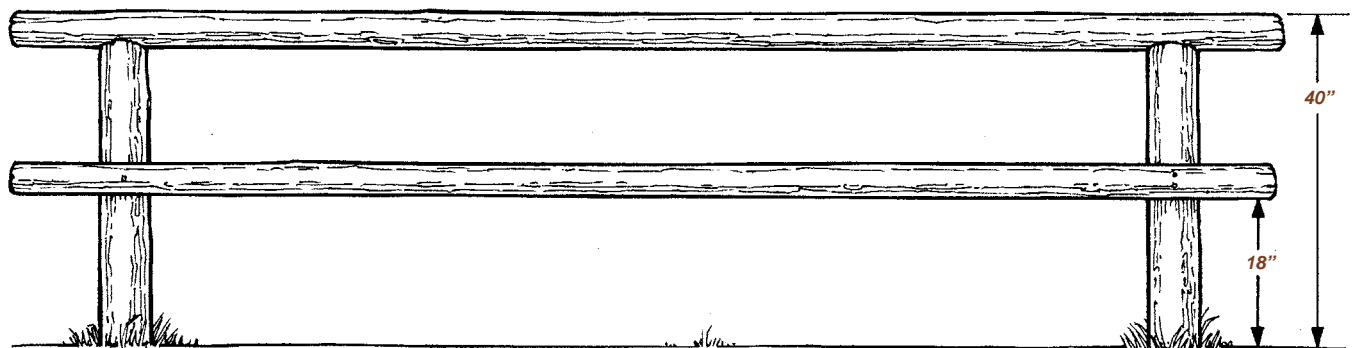

## POST AND WIRE FENCE

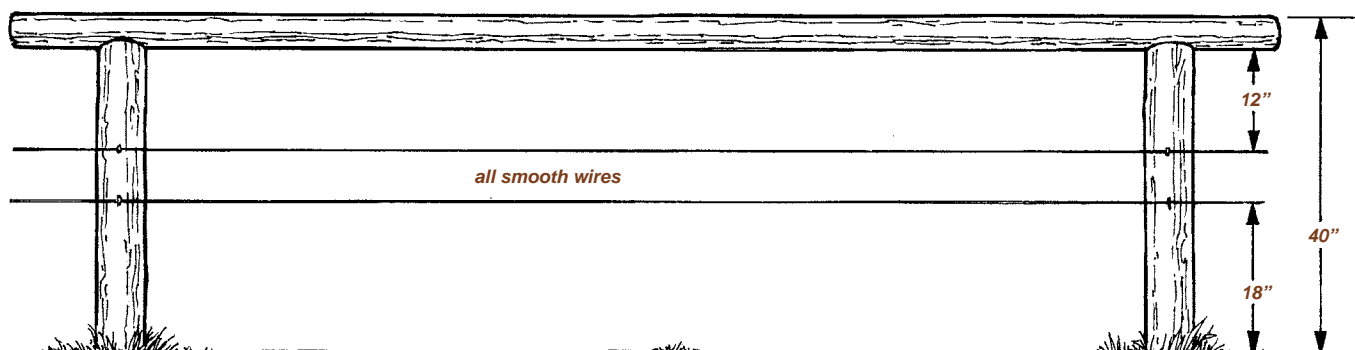



## Friendly Designs

### WORM FENCE

Worm fences, also called zigzag or snake fences, were used by early settlers, especially where clearing homesteads of timber, because they are easy to construct and require no posts. Worm fences are still popular in some areas for their rustic nature, especially as boundary fences. They are not used to contain large livestock.

Although worm fences are more easily negotiated by wildlife than three-dimensional jackleg fences, they can still be a barrier to fawns, calves and other animals. Other drawbacks include rotting, the excessive number of rails needed, the considerable space the fence takes up on the ground, and maintenance to rebuild collapsed sections.

Worm fence is simply constructed of rails stacked alternately on top of one another, with the rails interlocked like laced fingers where the ends meet. The fence zigzags to give it stability, and it can be used where posts can't be driven into the ground. These fences are usually only two to three feet high, and are most often used in



Christine Paige

mountainous areas where local timber is readily available and the terrain tends to be rocky and uneven. If you use a worm fence, create openings for wildlife to cross by intermittently dropping rails to the ground.

- Use three to four stacked rails per section, 8' to 11' long;
- Logs or split rails can be used. Rails split in a triangular manner add stability;
- Set the ends of each bottom rail on a rock or short log slightly above the ground to postpone decay;
- Interlace the rails at joints at a 30-degree angle;

A low worm fence is easily hopped by most ungulates. Drop the top rail to the ground every few hundred feet to allow smaller animals cross.

- Stack rails only up to a 2' to 3' height;
- If extra stability is needed, fasten rails together with 6" nails or spikes, and drive 4' lengths of 1/2" rebar into the ground on either side of the joint, flush with the top rail;
- Drop rails to ground every 400', and in swales and at stream crossings for easy wildlife passage.



Christine Paige

## *Sites with High or Continuous Livestock Use*

Most livestock pastures do not require a five- to six-strand barbed-wire fence. In many situations, a three- or four-strand barbed-wire fence, a combination of smooth and barbed-wire, or a high-tensile electric fence will work well for livestock control, particularly if the pasture quality inside the fence is as good or better as outside the fence.

Sheep, bison and cows with calves may require more impermeable fence for control. If you must use fences with woven

wire or more than four wires follow these tips:

- Consider the placement of the fence perimeter carefully, and limit the extent of impermeable fence whenever possible.
- Avoid excluding wildlife from streamsides and water sources, or cutting off migration and travel corridors.
- Keep the fence height to a maximum of 40" to 42" and create periodic crawl-openings for fawns and calves by raising the bottom 18" from the ground, placed where animals typically travel.
- Avoid topping woven wire fences with barbed-wire. In any situation, allow 12" between the top wire and the next wire below – whether barbed or woven wire.
- Create seasonal openings using lay-down fence sections or gates to open the fence during months when stock are not present.



## Friendly Designs

### 4-STRAND BARBED-WIRE FOR CATTLE OR SHEEP

Woven-wire fences block wildlife passage, particularly for fawns, calves, pronghorn and medium-sized animals unable to jump over fence. On cattle and sheep range, it is possible to use a four-strand barbed-wire fence that controls livestock but still allows for passage of pronghorn, deer, moose and elk.

For cattle, use a wire spacing of 18–22–28–40/42 inches. The top wire should be at 40" to 42" or less. Allow 12" between the top two wires and 18" between the bottom wire and the ground. Use a smooth bottom wire.

A four-strand fence for sheep can have a top wire no more than 32" high. Allow at least 10" between the top two wires. (A lower fence is easier for deer and elk to jump, and so the 10" spacing between top and second wires will usually be adequate.) The bottom wire should be smooth wire and at least 10" above the ground.

- Top wire height 32" maximum for sheep, 40" to 42" for cattle; or 38" for both sheep and cattle.
- At least 10" to 12" between the top two strands.
- A bottom smooth wire, at least 10" above the ground for sheep or sheep/cattle fence, and 16" to 18" for cattle.

### COMBINATION SMOOTH AND BARBED-WIRE FENCE

In many situations, a combination of smooth wire and barbed-wire can effectively contain livestock and allow for easier wildlife passage. Smooth wire can be used for the top and bottom wires and one to two barbed-wire strands are used for the center strands. High-tensile wire can be used on top, and poly-coated white high-tensile wire will increase visibility for wildlife. The top wire should be 40" to 42" high or lower, and the bottom wire at least 18" above the ground to provide wildlife clearance. Allow at least 12" between the top and second wires.

- Place top smooth wire at 40" to 42" maximum height – high-tensile or poly-coated white high-tensile wire is recommended.
- Allow at least 12" between top and second wires.
- Place bottom smooth wire at least 18" from the ground.
- Use barbed-wire for center two wires.

### SHEEP AND CATTLE 4-STRAND BARBED-WIRE FENCE

(Adapted from Wyoming Game and Fish Dept., 2004)

#### Recommended Wire Heights Above the Ground

	Cattle	Sheep	Sheep & Cattle
<b>Top wire</b>	40" to 42" barbed	32" barbed	38" barbed
<b>2nd wire</b>	28" barbed	22" barbed	26" barbed
<b>3rd wire</b>	22" barbed	16" barbed	18" barbed
<b>4th wire</b>	16" to 18" smooth	10" min. smooth	10" min. smooth

### 4-STRAND BARBED-WIRE WITH BOTTOM SMOOTH WIRE

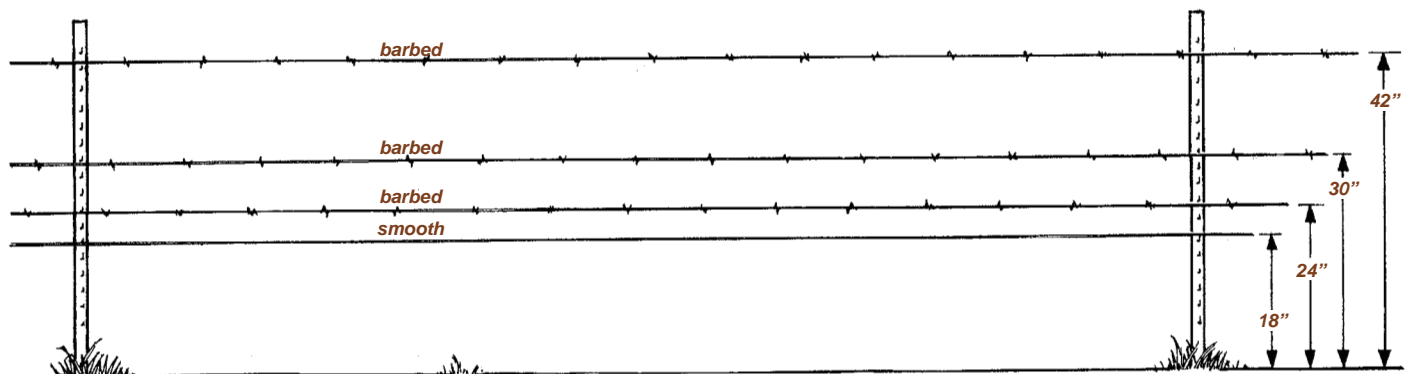



## Wildlife-friendly Klick Ranch

**“When I drove in here yesterday, I parted mountain sheep like Moses did the Red Sea.”** Dick Klick is talking about the road to his place at Castle Reef, 23 miles west of Augusta, Montana. Dick and his wife Nancy winter their horse herd here, and have made some adjustments to deal with the bighorn sheep, deer and elk that share their property.



Christine Paige

On their winter place, the Klicks build mostly four-wire fence. The top two wires are barbed, while the bottom two are smooth. The top wire is hung 54” from the ground, and the wires are spaced 10” apart (24–34–44–54” spacing). The fence hangs from six foot steel posts spaced on 17-foot centers.

Although the top wires are very high, the high clearance under

the bottom wire allows wildlife to easily slip under and avoid accidental entanglement. When Dick notices an area that is used consistently by wildlife, he often pulls staples on sections of his bottom wire, raising it up to the level of second wire to make crossing even easier. Even modified this way, the fences effectively contain his horses.

In the summer, the Klicks graze their horses at the head of the Gibson Reservoir, on a 3,000-acre Forest Service allotment bordering the Bob Marshall wilderness. Their place is remote, accessible by jet boat or horse depending on the season.

On the doorstep of the Bob Marshall, the Klick’s allotment is used extensively by wildlife. In the summer and early fall, the horses share the range with a large number of elk. Wherever



FVP

possible, the Klicks have relied on natural barriers such as cliffs, steep slopes and box canyons to contain their herd. To keep wildlife from damaging the three miles of fence they’ve built on the allot-

ment, Dick and Nancy have experimented extensively with design, location and wire spacing.

The layout they favor is two barbed wires, the top wire at 48”, the bottom wire 8” below that at 40”, leaving ample clearance below. “It’s 99% good for holding horses,” says Dick. “The bull elk jump it, and everything else goes under easily, without even causing a ripple.”

Dick stresses the importance of fence visibility in reducing wildlife conflicts. He finds that fencing through dense trees often results in wildlife damage. Because of this, he generally leaves a buffer zone between his fence and the tree line in meadows. When forced to go through trees, and if his Forest Service lease allows it, Dick clears a pathway on either side of the fence to increase its visibility to wildlife.

Replacing old fence with new, more wildlife-friendly designs takes thought and effort, but Dick seems happy with the balance he’s struck. The new fences are easier to maintain, and stand up better to wildlife crossings and snow drifts.

“I’m getting older,” Dick says. “I don’t like to see a quarter-mile of fence strewn across the place by wildlife. We must work with animals up here.”

– Bryce Andrews



## Friendly Designs

### 3-WIRE HIGH-TENSILE ELECTRIC FENCE

Researchers in Wyoming found that a 3-wire high-tensile fence (with a hot – ground – hot configuration) is not only effective for containing cattle and bison, but allows elk, mule deer and pronghorn to traverse the fence. They found that wild ungulates usually were not deterred by electric fences even with charges ranging from 0.5 and 4.5 joules, perhaps because of the insulating properties of their hair. Although wild ungulates were occasionally shocked when they nosed or bit a wire, or touched hot and grounded wires together, most animals readily negotiated the fences.

Further, the researchers determined that 3-wire fences effectively contained bulls separated from cows coming into estrus, and calves from cows in the fall. Also, they found that a 3-wire fence was just as effective for containing bison as a 4-wire fence. A 2-wire fence can be used for areas without weaning calves

but, curiously, pronghorn showed a high aversion to 2-wire fences, perhaps because of the novel height and their general reluctance to jump fences rather than crawl under (Karhu and Anderson 2003, 2006).

Note that high-tensile fences require proper construction techniques, including adequate braces, proper tensioning, care not to kink or break wire, and proper attachments and insulators for posts and braces. However, high-tensile fences need minimal maintenance, provide great strength, can be easily electrified and will outlast most other fences.

- Maintaining fence flexibility is key to allowing wildlife to traverse the fence.
- Use fiberglass posts no greater than 1" in diameter;
- Brace fence with wood posts at least 5" in diameter; use braces at all corners, gates, and direction changes greater than 15 degrees. Appropriate insulators are needed with wooden posts.

- Space posts at a minimum of 50' apart if stays are used, and maximum of 50' apart with no stays;
- Fence stays can be problematic, making it harder for wildlife to pass between the wires, sometimes causing the fence to flip and twist when wildlife cross, and increasing the risk of grounding out the fence. If stays are used, the free span should be at least 30' for wildlife to cross effectively;
- Smooth, 12.5 gauge, Class III galvanized wire with a tensile strength of 170,000 PSI and breaking strength of 1308 lbs. is adequate. To increase visibility, for the top wire use white poly-coated wire with the same specifications;
- Space wires at 22–30–40/42" from the ground. The top wire should be no higher than 42" with 10" to 12" between the top and middle wires. A bottom wire at 22" allows both young and adult wild animals to pass under easily. Connect wires to

### 3-WIRE HIGH-TENSILE ELECTRIC FENCE

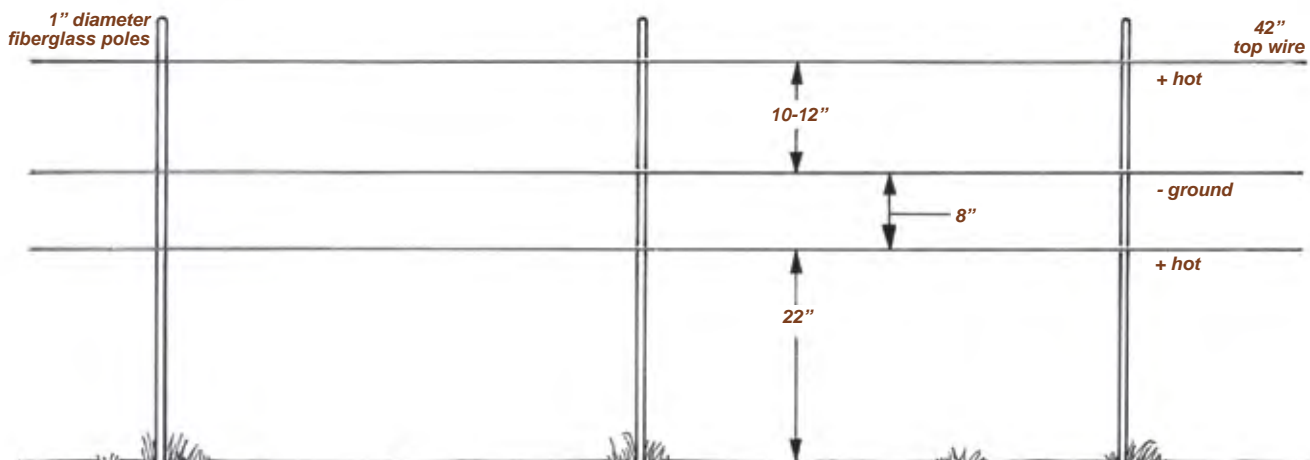



Photos: Rory Kanhu



posts with metal clips or fasteners designed for electric fences;

- Top wire is hot; second wire is grounded, bottom wire is hot;
- Tighten wires to 150 lbs tension. If too tight, the wires are more likely to break. Although high-tensile wire has a high breaking point, it is also more brittle, and easily broken if tightly bent or kinked;
- Place solar energizer according to manufacturer recommendations;
- Ground fence properly according to the energizer instructions, and add extra rods as needed. Locate ground rods at fence ends and intermittently in between.
- Keep fence electrified even when livestock are not present to prevent wildlife damage to

A 3-wire high-tensile power fence is effective even for separating bulls from cows in estrus, and for containing bison. Using high tensile wire at the proper tension is key to prevent wildlife damage.

fence. This also prevents the battery from freezing and prolongs battery life.

- Securely attach electric fence warning signs intermittently along the fence and at crossing points.



### *Power Fences on the Sun Ranch*

**Sun Ranch manager James Stuart and his crew keep pretty busy.** The 18,000 deeded acres of the ranch, situated in the foothills of the Madison Range in southwest Montana, provide critical fall, winter and spring habitat for thousands of elk, and year-round range for deer and pronghorn. All this wildlife traffic, combined with a summer grazing operation that brings on nearly 2,000 head of cattle, puts a lot of pressure on the fences.

Over the past decade, the Sun Ranch management has tried out innovative fence designs to improve wildlife passage without sacrificing the ability to hold cattle. To make room for experimentation, ranch staff has torn out more than thirty miles of problematic barbed-wire fence over the course of the last decade, often with the help of volunteers from conservation groups like the Rocky Mountain Elk Foundation and Greater Yellowstone Coalition.

One of the simplest and most effective ways of reducing wildlife conflicts, Stuart found, was using temporary fence wherever possible. His preferred design is a single strand of polywire – a woven mix of plastic strands and conductive wire about the diameter of baling twine – hung 36” high from fiberglass posts on 50-foot centers. Using a specially equipped wire buggy,

two ranch hands can build this fence at a rate of half a mile per hour, and pick it up again at a rate of two miles per hour. The ranch owns about 8 miles worth of posts, polywire, and solar-powered energizers, which they use extensively through the summer grazing season.

Stuart stresses that the electrified polywire is a psychological barrier rather than a physical one, and that it helps to train cattle to respect it in a controlled environment. To do so, the crew builds a short stretch of power fence in a corner of their shipping pens, and expose new cattle to it as they arrive on the ranch. “One good shock,” Stuart says, “and they get the idea.”

As a single-strand fence, the polywire is easy for wildlife to negotiate. Although elk and deer can damage it, especially if they come through in the night, Stuart feels that temporary fence has been an extremely effective tool for improving wildlife passage, manipulating livestock grazing patterns, and reducing time spent repairing fence in the spring.

Where the crew built new permanent fences, two designs emerged as especially effective. One is a three-wire let-down electric fence built with wood posts and pin lock insulators. Following the grazing season, all three high-tensile wires are dropped to the ground, where



Bryce Andrews

they stay all winter. The extra work of raising and lowering these fences twice a year, says Stuart, is nothing in comparison to patching elk damage in traditional barbed-wire fences.

The other key design is a two-wire electric fence hung from one-inch diameter fiberglass posts on 50-foot centers. The top wire is hot, and hung 32” from the ground. The grounded bottom wire runs 12” below it. “Pronghorn go under easily, and everything else goes over. Because the fiberglass posts can flex, the fence tends to bend instead of break.” Although a two-wire fence may seem like an insubstantial barrier, Stuart stresses that this fence contains cattle very well, and that he’ll be building more of it in the future.

– Bryce Andrews





## Openings, Crossings and Passes

To modify any fence design, you can include openings and crossings in your fence to allow wildlife passage for periods when livestock are not present. Fence passes keep fawns and calves from being stranded, provide openings for other animals unable to jump fences, and help wildlife cross when snow hinders passage over or under fences. Wildlife crossings are especially important when fawns and calves are small, from June 1 through the summer, and for seasonal wildlife movements and ranges.

Such openings can considerably reduce wildlife damage to fences and decrease maintenance costs.

Wildlife openings can include sections with drop-down wires or rails, lay-down fence, or simply additional gates secured open. The local topography and patterns of wildlife travel should help determine the placement of crossings. Look for signs of wildlife use and travel such as tufts of hair caught on fence wires, game trails, trails to water, or gullies and swales that act as wildlife corridors.

Wildlife crossings can include:

- Individual sections built to wildlife friendly standards;
- Drop-down wire or rail fence designs;
- Lay-down fence;
- Extra gates, secured open for wildlife;
- PVC modifications to wire fence for ungulate passage.

Elk and other wildlife readily travel through seasonal fence openings. Here a wildlife gate is installed on an elk trail.





## Friendly Designs

### **DROP-DOWN FENCES: DROPPED RAIL**

Jackleg fence, high post-and-rail fences, and worm or zigzag fences are often used for

property boundary fences, but may be difficult for some animals to negotiate. An occasional gap in the fence can provide a crossing. Animals will often move along the length of a fence seeking an opening. Simply drop the rails to

the ground every 400' to allow animals to step across. Rails should be dropped where there are signs of wildlife passage, such as game trails, and in stream corridors, gullies or other natural funnels.

### **DROPPED RAIL FOR WILDLIFE JUMP**

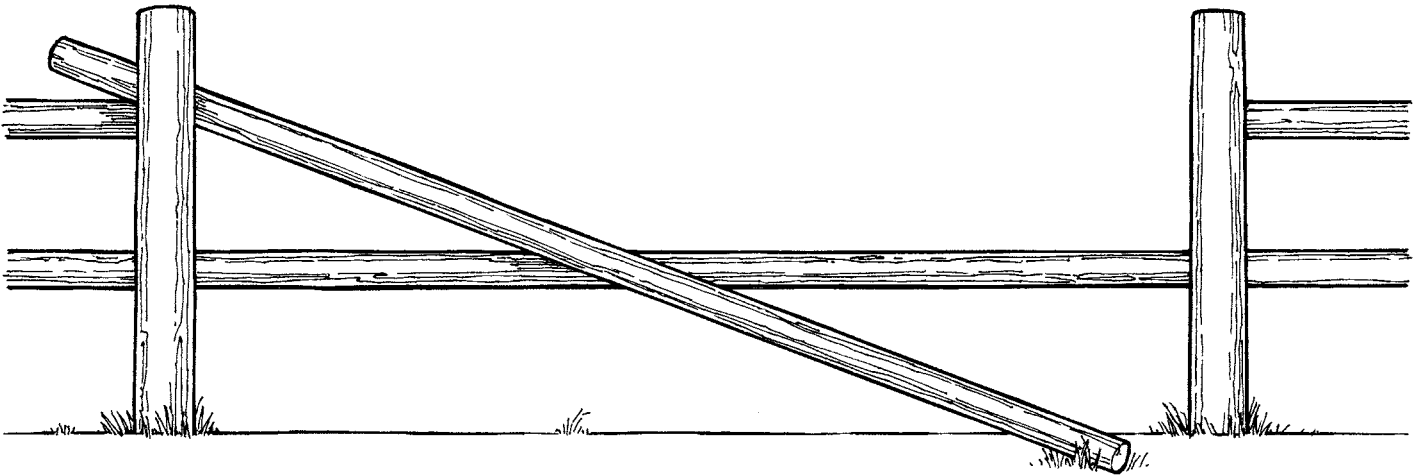

### **DROPPED RAIL IN JACKLEG**

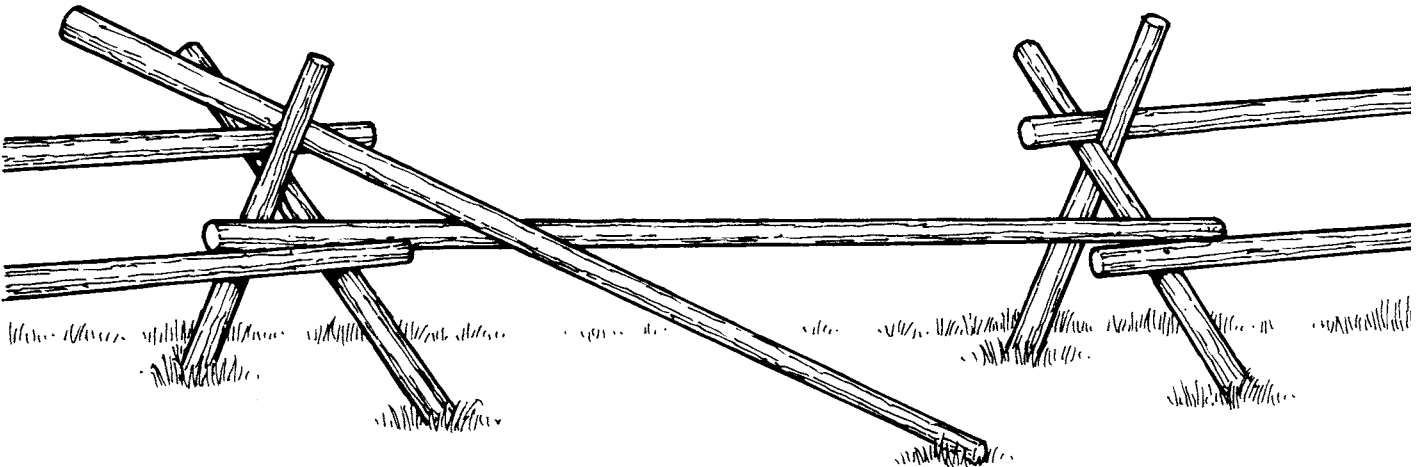



## DURABLE PVC BIG GAME PASSAGE

Installing PVC pipe over bunched fence wires is an inexpensive way to allow elk, deer, and antelope to freely cross existing barbed-wire fence with minimal risk. This design is especially useful where elk, moose or other ungulates cross heavily traveled roadways and have difficulty crossing a fence, delaying their movement out of danger – particularly in spring and summer when calves are small. Along roads, the PVC passage should be installed on both sides of the right-of-way.



FVP



FVP

PVC pipe threaded over bunched fence wires creates an effective and durable big game passage.

These instructions are for a metal t-post, 5-strand barbed-wire fence, with no livestock present, but can be adapted for other situations.

### Materials for modifying two 60' sections of barbed-wire fence:

- Twenty 10' sections of 1.5" OD PVC pipe
- One 100-count bag of large (7" or 11") UV-resistant plastic cable ties
- #16 or larger soft wire
- fencing pliers, wire cutter, leather gloves

### Before Installation:

With a table saw, cut a 1/4" slot the entire length of each PVC pipe. Note that a 1/4" cut can be made by matching up two 1/8" wide blades and using a wood guide.

### Installation:

**Step 1:** Remove all wire clips from about 50' or three fence posts and allow wire to hang freely.

**Step 2:** Beginning near first post with clips removed, grip the **top three strands** of wire and pinch together. Locate a space between barbs that will allow you to thread on the PVC pipe. Push pipe onto wire (not wire into pipe) concentrating on fore-end of pipe. If the pipe gets hung up on a barb at the fore-end, work barb into end of pipe and continue. Once the pipe has been adequately started, grip pipe near the fore-end and

begin pulling down the length of the wire. The wire will feed itself into the pipe. Pull pipe down the wire until about 8' from where posts with clipped wires resume.

**Step 3:** Repeat with three more pipes. Space the joint between two pipes at a post where possible. This will allow you to clip the three wires together to a post.

**Step 4:** The last (fifth) pipe must be installed in the reverse direction. Starting near the end of the fourth pipe, find a space between barbs and install pipe as in Step 2, push into place 8' from where posts with clips resume.

**Step 5:** Repeat steps 2 through 4 with the bottom two wires.

**Step 6:** Using #16 or larger soft wire, attach the top PVC pipe to posts no more than 40" above the ground. Attach the bottom pipe at 18" above the ground, or dropped closer the ground to create a larger middle gap for deer fawns/elk calves to go through rather than under. Where a joint between pipes is located at a post, enough space can be left to clip the wires to the post.

**Step 7:** Attach three cable ties per 10' section of PVC pipe, one near each end and one in the middle. Squeeze PVC pipe while pulling cable tie tight. Gap from cut will not be completely closed but will be small enough to allow the pipe to roll and not work its way off the wire. Clip tag end of cable tie.



# Friendly Designs

## DROP-DOWN FENCES: ADJUSTABLE WIRE FENCE

Adjusting the height of one or more wires is an easy and effective way to allow animals to cross during migration periods if livestock aren't present. Drop the top wire to the level of the second wire, either in sections or along an entire run of fence, to allow wildlife to jump over easily. Lowering the top wire to 25" or less allows elk and deer to hop

over easily in almost all conditions. Raise the lowest wire in the same way to help wildlife crawl under. A simple staple lock allows wires to be rapidly adjusted from one level to another and the wires can be adjusted by only one person.

Existing fences can be readily modified by installing staple locks to create a drop wire so wire height can be adjusted when livestock are not present.

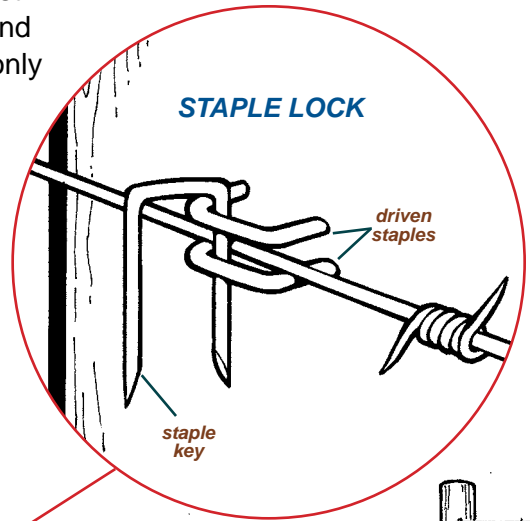

## ADJUSTABLE FENCE FOR SEASONAL WILDLIFE PASSAGE

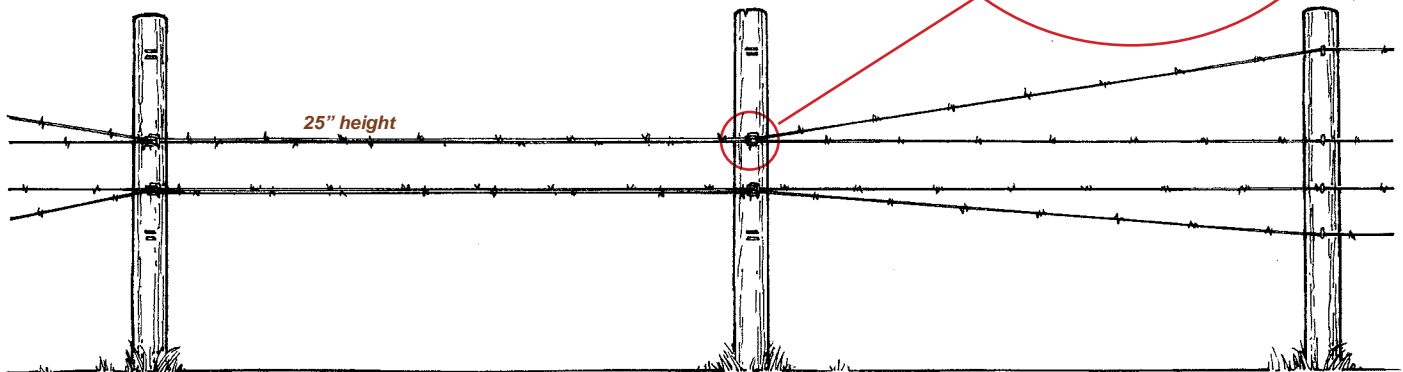

### Staple lock for wooden posts:

- Install two fence staples horizontally and less than an inch apart on each post at the level of both the top wire and the second wire.
- Slip the fence wire between the two staples.
- Secure it in place by hooking a third staple through the paired staples vertically, like a latch.



Marina Smith



## Searching for Solutions in the Madison Valley

**Marina Smith knows how difficult it is to reconcile the needs of livestock and wildlife** as well as anyone: she's been managing ranches at the south end of the Madison Valley for years. The properties in her charge sit astride an antelope migration corridor and provide crucial habitat for elk and deer.

Initially, much of the property had woven wire and jackleg fence, and wildlife conflicts were commonplace. On one occasion, a black bear was stranded between the highway and a woven wire fence. Panicked, the bear tested the fence repeatedly, unable to pass through or over it. Smith's challenge was to replace fences like this one with new designs more permeable to wildlife, but ones that would also reliably hold cattle for summer grazing.

Smith has torn out close to thirty miles of old fence. She has experimented with various fence designs – with mixed results. On the Elk Meadows property, she installed stretches of high-tensile electrified fence. These fences were highly effective for livestock containment when fully charged. However, many of the electric fences ran through areas with steep topography, rocky soil, and much wildlife traffic, making them suscep-

tible to wildlife damage and difficult to maintain.

Smith also theorizes that wildlife have a hard time seeing the electric fences as they can be built with thinner posts and fewer wires than traditional fences. Wildlife collisions frequently



Christine Paige

grounded out the fence, reducing its ability to hold cattle. (This problem might be mitigated by using high-visibility wire, flagging or other markers.) Sections of suspension fence, where posts were set at relatively long distances from each other and the wire spans stiffened with wire or wood stays, fared even worse. In the process of crossing, elk would often cause the fence to twist. When inverted, the stays would catch on the ground, compromising the fence.

Smith found that the design that best balances her livestock production needs with her desire to enhance and protect wildlife habitat is a four-strand barbed-wire fence with a drop-down top wire. The top wire is hung at 42" inches and secured

Ranch manager Marina Smith found that a seasonal drop-down top wire allows migrating elk to easily pass over the fence in fall and winter.

with a staple lock; the bottom wire is 18" from the ground. During fall and winter, in areas that serve as movement corridors for wildlife, Smith drops the top wire to 36 inches. Observing the way that way animals interact with the drop-wire fence has led Smith to conclude that these wire heights are critical for allowing wildlife passage.

– Bryce Andrews



# Friendly Designs

## DROP-DOWN FENCES: LAY-DOWN FENCE

A lay-down fence is a standard 3-wire or 4-wire fence that can be laid on the ground as a unit to allow ungulates to pass through during migration or seasonal use. A lay-down fence can also reduce snow and wildlife damage and save maintenance costs. Most designs allow a single person working alone to let the fence down or put it back up.

Lay-down fence can be constructed from smooth wire or

barbed-wire. Fence posts can be wooden or steel, but wood is more durable in heavy snow areas. Posts should be spaced at 16.5' intervals.

For barbed- or smooth-wire fence, one to two stays are needed between fence posts, plus a stay lined up with each fence post. Wire loops, secured at the top and bottom of the fence posts, support the fence stays. Be sure the fence stays do not touch the ground. The lay-down section can then be dropped by flipping up the top loop and lifting the stays out of the bottom loop.

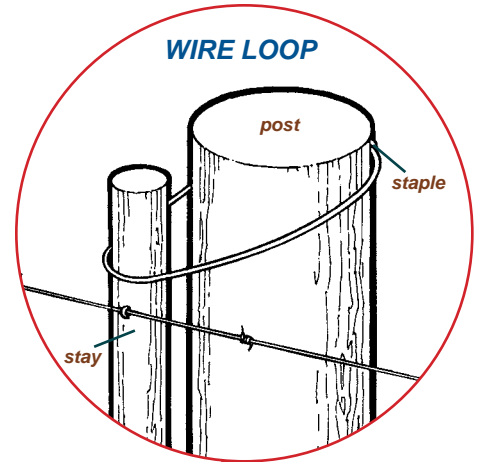

## LAY-DOWN FENCE

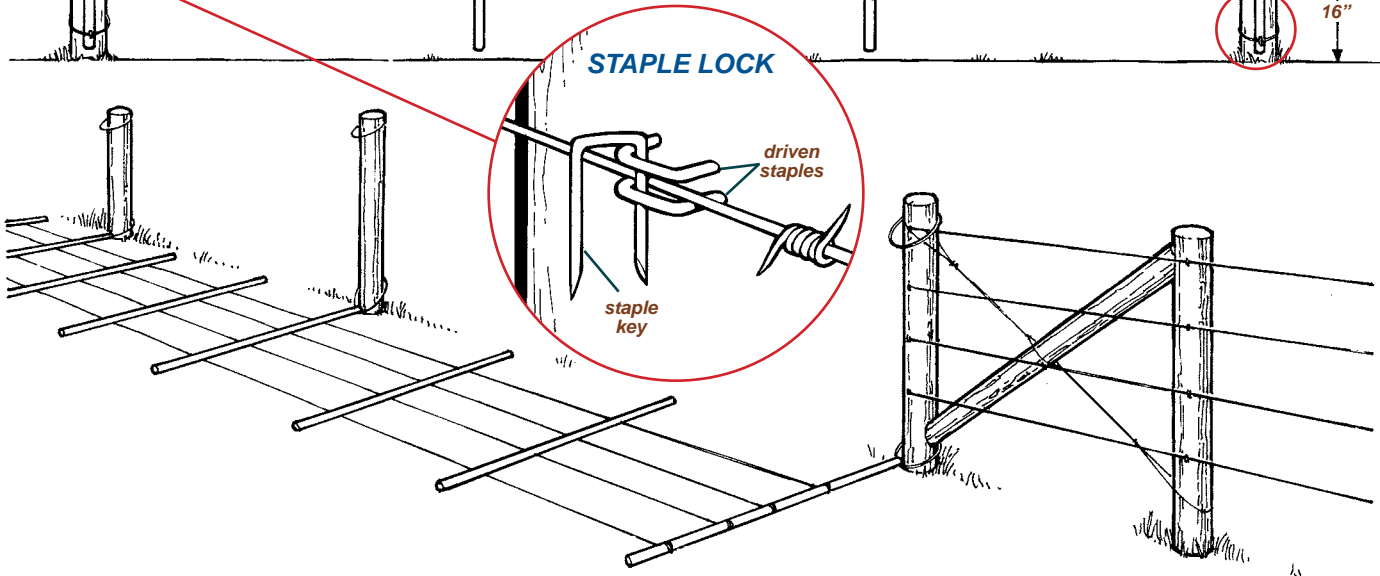
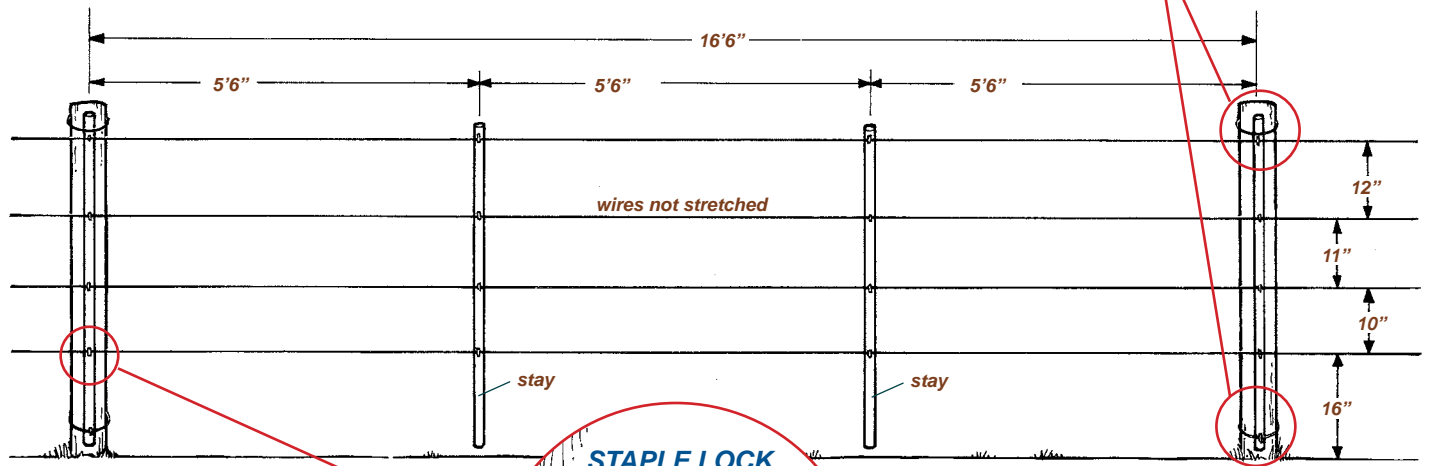



FWP



Jay Kolbe

This lay-down fence using four-strand smooth wire was constructed along 1.5 miles of fencelines next to the Blackfoot-Clearwater Wildlife Management Area to allow winter passage for elk. The number of elk tracks attest to the design's success.



Christine Paige



## Friendly Designs

### PRONGHORN UNDERPASS OR "GOAT BAR"

Although capable of jumping even high fences in extreme situations, pronghorn prefer to crawl under fences, and almost seem unaware of their ability to "high jump." They will often run for miles looking for fence openings or spots to crawl under a fence, and have been known to die of starvation when blocked by a fence they see as impassable.

Pronghorn have the greatest difficulty negotiating sheep fence, which either uses lower barbed-wire strands than cattle and horse fence, or is typically made of woven wire. However, a pronghorn "underpass" can be created by raising the bottom strand in selected fence sections.

- For sheep, space wire strands at 10–16–22–32" above the ground, the top three strands barbed-wire, the bottom strand smooth wire.
- In selected sections, raise the bottom smooth wire on two posts to the height of the third wire, securing in place with a staple lock. The smooth wire can be dropped again if needed.



Randy Gazda

Pronghorn will readily use any section with a slightly raised bottom wire to crawl under a fence.

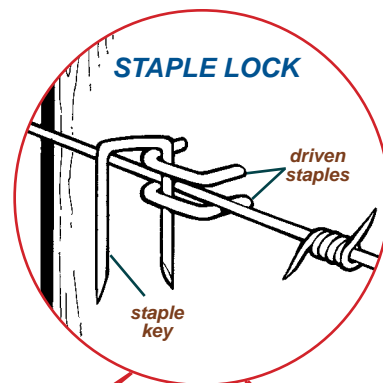

### PRONGHORN UNDERPASS FENCE WITH RAISED WIRE

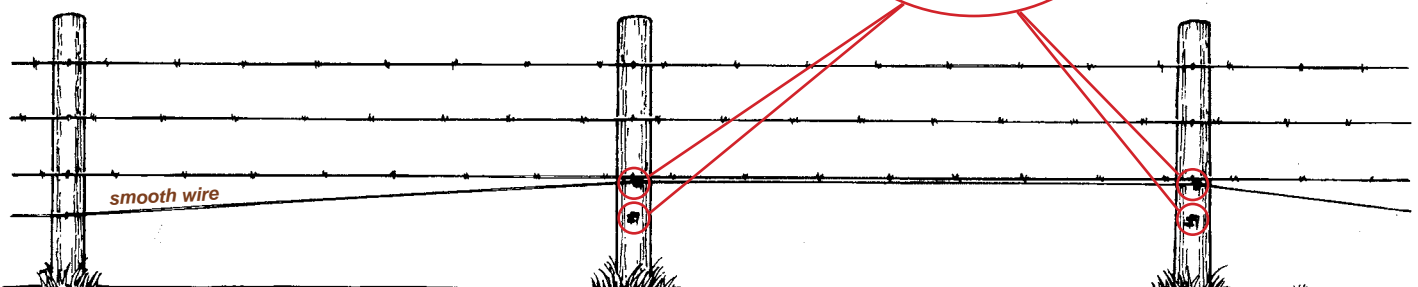





## PRONGHORN UNDERPASS FENCE WITH GOAT BAR

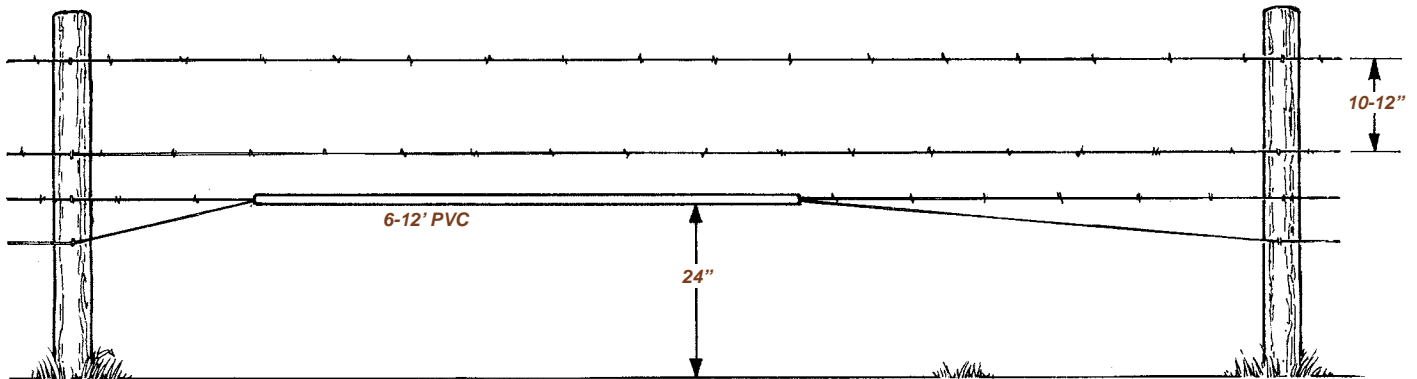

Where cattle or horses share the range with pronghorn, a PVC underpass or “goat bar” can be created by simply gathering the bottom two wires in a PVC pipe to make a higher clearing for pronghorn of any age to crawl under. Despite the underpass, the fence remains effective for controlling horses and cattle. This design has been used extensively in pronghorn habitat.

- Space fence wires heights at 18–24–30–40”; use smooth wire on the bottom.
- Cut several 6’ to 12’ lengths of PVC pipe.
- With a table saw, cut a 1/4” slot the length of each PVC pipe. Note that a 1/4” cut can be made by matching up two 1/8” wide blades and using a wood guide.
- Grip the bottom two fence wires together, and feed the PVC pipe onto the wire from one end of the pipe. If the pipe gets hung up on a barb at the fore-end, work barb into end of pipe and continue. Once the pipe has been adequately started, grip the pipe near the fore-end and begin pulling down the length of the wire.
- Space these underpasses intermittently along the fence, and especially in fence corners where pronghorn may be directed by the run of fence.



FWP



## Remedies for Existing Fences

### Remedies for Existing Fences

**How can you make existing fences more wildlife friendly? Fence maintenance, modifications and removal can all help wildlife.**

#### Maintenance:

- Keep wires tight. Sagging wires and neglected fences create a hazard for both domestic animals and wildlife. Loose wires can snare animals as they attempt to cross – tight wires reduce the chance of entanglement.

#### Modifications:

- Replace barbed-wire with smooth wire wherever possible. Smooth wire reduces the chance of animals becoming snared on barbs and fatally entangled.
- Adjust the height of top wire: preferably no more than 40” and a maximum of 42” above the ground
- Increase the distance between the top two wires to 12” to reduce entanglements.
- Reduce the number of wires to three, or at most four.
- Add a top rail, high visibility top wire, a PVC cover on the top wire, or flagging to increase visibility and prevent entanglement.



Scott Nicolarsen

- Raise the bottom wire to at least 18” above the ground to allow animals to crawl under:
  - In selected sections, raise the bottom smooth wire on two posts to 18”, securing in place with a staple lock.
  - For pronghorn, gather bottom wires in a PVC pipe to create a “goat bar” underpass.
- Add wildlife crossings where wildlife trails cross fences by using dropped wires, dropped rails, lay-down fence or underpasses, as described earlier.
- Provide wildlife access to rivers, streams, wetlands and water holes, and through seasonal migration areas.

#### Removal:

- Remove old fences that are in disrepair or no longer in use. Remove any unnecessary interior fences.
- Bale and carry away piles of wire. Some recycling centers will recycle old wire.
- Many volunteer groups are interested in helping with fence removal projects to help wildlife, such as local chapters of sportsman’s groups, scout troops, 4-H and others.



## Fence Alternatives

**If you do not need a fence to contain or exclude livestock, consider other creative ways to define boundaries and discourage trespass.**

### HEDGEROWS

A line of shrubs and trees can mark a boundary line, beautify your landscape and provide food and cover for wildlife. Depending on the site, a wide range of native and ornamental shrub species can be used to create an effective hedgerow – from lilacs and honeysuckle to willows, alder and big

sagebrush. Your county extension service can help you find local sources for plants and choose appropriate species for your site.

Many native Montana shrubs are suitable for hedges and enhance wildlife habitat. These include American chokecherry (*Prunus virginianus*), black hawthorn (*Crataegus douglasii*), red-osier dogwood (*Cornus stolonifera*), serviceberry (*Amelanchier alnifolia*), Rocky Mountain juniper (*Juniperus scopulorum*), wild rose (*Rosa woodsii*), and willow (*Salix species*).

**Beware using some non-native species.** Although Russian olive (*Elaeagnus angustifolia*), common buckthorn (*Rhamnus cathartica*), and tamarisk (*Tamarix species*) are still sometimes recommended as hedge or ornamental plants, these species are highly invasive and can cause irreparable damage to the landscape.

**Mix it up:** consider using several species, varying the width of the hedgerow, or using plants of different heights to create a natural and wildlife-friendly hedge. Once established, hedgerows require minimal maintenance unless you want a highly manicured look.

### HEDGEROW





## Fence Alternatives

### BOUNDARY MARKERS

Where you do not need a fence, consider marking property boundaries with signs, flexible fiberglass or plastic boundary posts, or fence posts spaced at intervals but without cross-wires.

Throughout Montana, orange paint of at least 50 square inches on trees, posts and gates is legal notice of “no trespassing without permission.” In addition, intermittently place boundary or no trespass signs to indicate on which

side the posted property lies in relation to the orange markings.

Property boundaries can also be marked with steel t-posts or flexible fiberglass or plastic posts such as Carsonite or Flexstake posts, available through survey and forestry suppliers. Commercial fiberglass and plastic marker posts are highly visible and durable. However the cost per post can be greater than a heavy-duty steel fencing t-post.

Posts can mark a boundary where fences are not needed. Flexible plastic posts can be ordered with reflective tape or custom lettering.



Photo courtesy of Carsonite Composites

### BARRIER POSTS

Barrier posts or bollards are short stout posts spaced to prevent access by vehicles. They can be used to define a driveway or parking area, or edge an expanse of lawn. Posts can be spaced closely together, or placed farther apart and connected with a heavy chain, cable or rail, from two to three feet high. Bollards and posts with low chains or rails pose little deterrent or hazard for wildlife.

Bollards can be made of wood, concrete, brick, stone, cast iron, aluminum, or steel; a row of evenly spaced boulders serves the same function. Some can be installed as fixed or removable posts. A wide variety of bollard designs and ornamental covers are also available commercially.



Christine Paige

Short concrete or wooden posts prevent vehicle access but pose no barrier to wildlife.



## If You Must Exclude

**There are times when exclusion fence to keep wildlife out is necessary.** If you must put up an exclusion fence, avoid fencing a large area that includes wildlife habitat. Focus exclusion fences on small areas for specific purposes, such as fencing around play areas, vegetable gardens, beehives, calving and lambing areas, or haystacks. Keep exclusion fence close to the activity you need protected, and allow wildlife to use other parts of the property.

For any exclusion fence, place gates at corners: an animal that inadvertently finds itself trapped inside is more likely to find escape through an open corner gate than through a side gate.

### WOODEN PLANK FENCE AND CHAINLINK FENCE

Chainlink fences and wooden fences with closely-spaced vertical planks are especially unfriendly to wildlife and can create a complete barrier to animals of all sizes, from turtles to moose. If you must use chainlink or plank fences, limit their use to small enclosures.

Yard fences and play area fences often do not need to be more than 4' high. If higher, be sure gates are kept secured to prevent animals finding their way in.

For small chainlink dog kennels, attach a roof to prevent wild animals from becoming trapped inside. A roof also provides shade and shelter for your pets.



Christine Paige

Use chainlink fences only for specific purposes, such as play areas and dog kennels.

### DEER AND ELK EXCLUSION FENCE

A permanent non-electric exclusion fence for deer and elk should be 7' to 8' high. A 7' to 8' wooden fence that animals can't see through is typically used around housing areas. For gardens, vineyards and other agricultural plots, 8' woven wire fence is more often used with posts set at 8' to 20' intervals, and the wire is brought tight to the ground. Make the top highly visible by using a top rail, high-visibility wire or flagging. Place gates at corners, where an accidentally trapped animal is more likely to find an escape.



Christine Paige

A 7- to 8-foot fence is an effective barrier to elk, but should be used only for specific needs, such as gardens or haystack yards.



# If You Must Exclude

## HAYSTACK FENCE

Several options exist for protecting haystacks from wildlife damage. These include electric, non-electric, temporary and permanent designs.

### Temporary Solutions

A simple and cost-effective solution is to wrap haystacks with heavy-duty plastic mesh netting, such as Deer-D-Fence (distributed in the U.S. by Tizer Lake Distributors, Jefferson City, MT). Deer-D-Fence is a 2x2" durable plastic mesh that is strong, lightweight and easy to handle. Haystacks and large bales can be wrapped quickly, and the netting is readily lifted off when not needed. This netting is especially useful for temporary applications, rapid installation, and remote settings.



Deer-D-Fence

Deer-D-Fence plastic netting can also be used as fencing instead of woven wire, and installed on wood or steel posts using UV-resistant zip-ties. The plastic is UV-resistant and durable, and materials cost is comparable to woven wire. However labor costs for fence construction can be greater than with traditional materials. Although the mesh would cause little harm to most large animals,

it is nearly invisible when erected and should be flagged to be visible to birds.

Temporary electric fences can also deter deer and elk from haystacks. For a temporary fence, lean 8' 2x4s up against the haystack, spaced about 10' apart. String and secure seven wires 10" apart around the fence posts, alternating the charged and grounded strands. Use insulators to attach hot wires to the 2x4s.

An alternative, particularly if the ground is frozen, is to poke fiberglass or steel rebar posts horizontally into the haystack to hold wires in place and away from the hay. (Note that insulators must be used to attach hot wires to wood or steel posts, but not with fiberglass or plastic posts.) Deer or elk can't jump over this set-up, and will receive a shock if they reach through for hay.

### FROZEN GROUND HAYSTACK FENCE

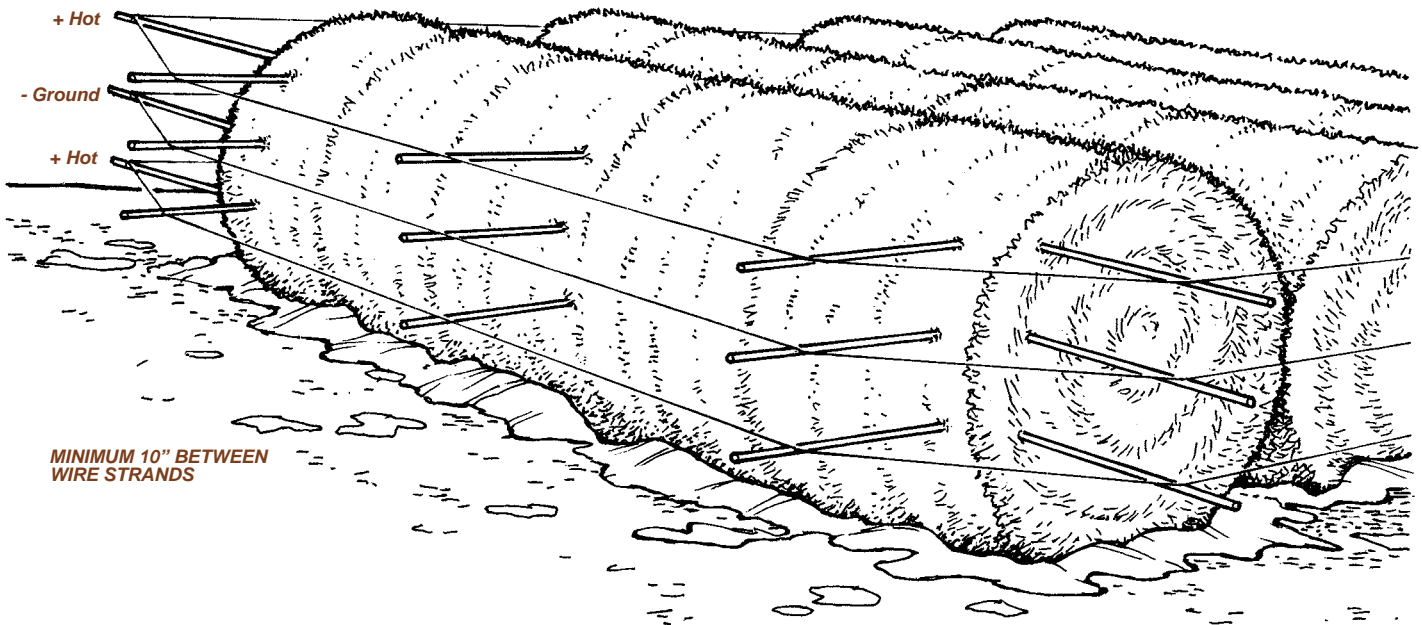



Christine Paige

Use a poly-coated wire or tape to increase visibility – it is important that animals be able to see the fence.

## Permanent Fences

Many landowners prefer to protect a large stackyard with a permanent fence. The traditional stackyard fence is at least 8' high and uses woven wire with wood posts or a combination of wood and steel posts. Gates should be placed in the corners to allow animals that might be inadvertently trapped inside to find a way out more easily.

A permanent electric fence, 7' high, is also effective for protecting stackyards from game damage. This fence is constructed

with 7 strands of high-tensile smooth wire, alternating hot and grounded strands, spaced at 12" intervals.

- Use 10' pressure-treated wooden line posts, 3" to 4" in diameter, driven 2.5' into the ground, and spaced at 30' intervals.
- Use 10' pressure-treated wooden brace posts, 4" to 5" in diameter, driven 3' into the ground.
- Use 12.5 gauge, smooth Class III galvanized wire with a tensile strength of 170,000 PSI and breaking strength of 1308 lbs. To increase visibility, use white poly-coated wire with the same specifications.

A traditional 8' woven-wire fence can protect a stackyard from game damage. An alternative is a permanent 7-strand electric fence.

- Space seven strands at 12" intervals; the top wire at 84"; wooden posts require using insulators.
- Alternate hot and ground wires: bottom wire is grounded and top two wires are hot.
- Place solar energizer according to manufacturer recommendations;
- Ground fence properly according to the energizer instructions.
- Install electric fence warning signs.



## If You Must Exclude

### 3-D DEER FENCE FOR YARDS AND GARDENS

Deer are not comfortable jumping fences with both height and depth, and are wary of fences that are not flat and regular. A staggered picket fence or leaning fence can be an effective deer deterrent. Another is to add tall vegetation – tall perennials, shrubs and trees – along a fence to increase the perceived depth of the barrier.

Another alternative is a 3-D electric deer fence, which can be effective for keeping white-tailed deer out of orchards and vegetable gardens. This fence is basically two parallel fences only 36" to 38" apart, the outside slightly shorter than the inside fence. The 3-D fence can be constructed as a permanent fence with high-tensile wire or as a temporary fence with poly-rope or tape and moveable posts.

- Place two separate lines of 4' fiberglass posts, the lines spaced 36" to 38" apart. Drive posts 16" to 18" into the ground

- On the inner fence, string two 12.5 gauge high-tensile smooth wires at 12" and 28" above the ground;
- On the outer fence, place two wires at 12" and 24" above the ground;
- Make sure there is at least a 12' clearing in front of the outer fence so deer will see the fence. Flagging or high-visibility wire also help both deer and people see the fence.
- Install a solar energizer according to manufacturer's instructions.

### 3-D ELECTRIC DEER FENCE FOR YARDS AND GARDENS

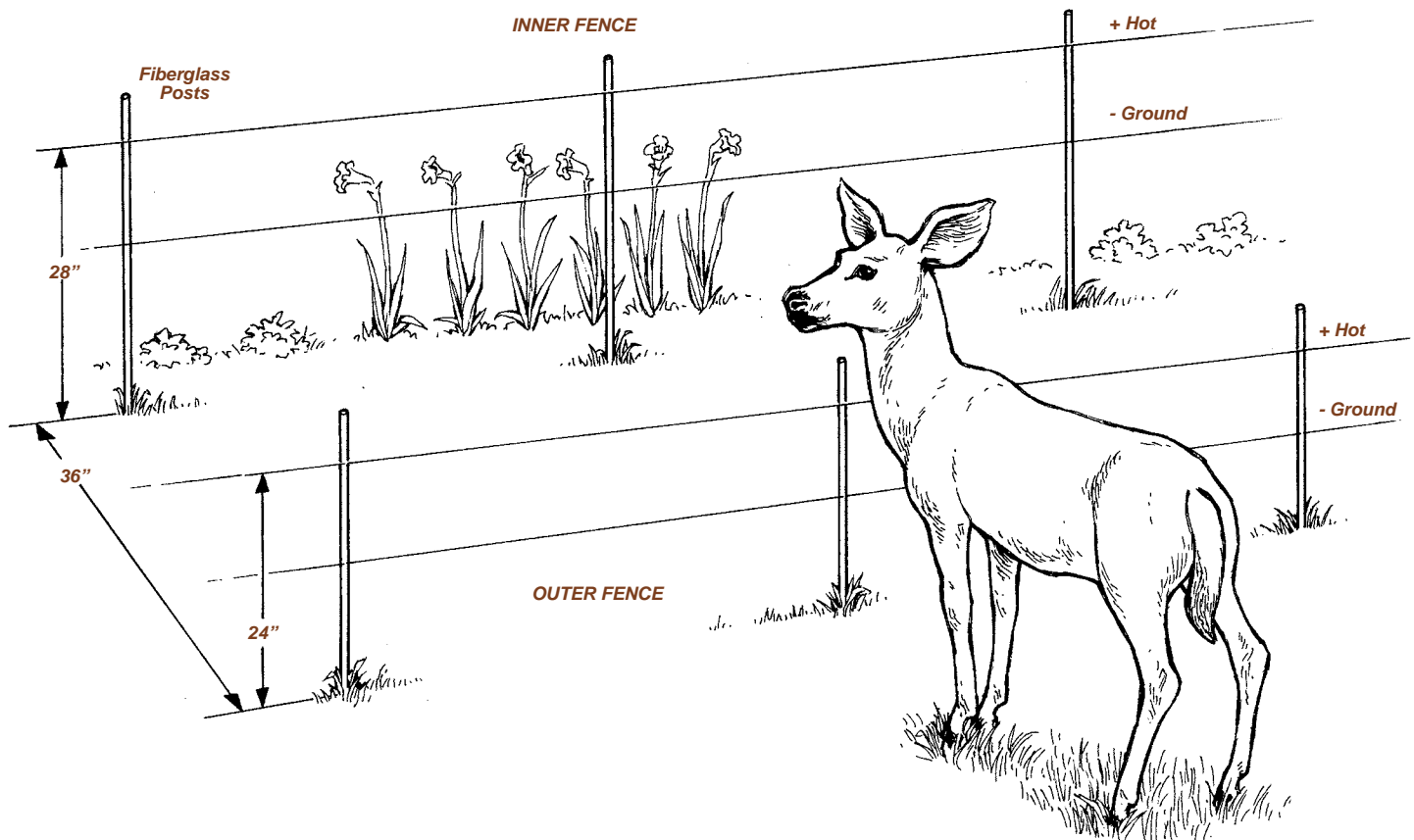





Seth Wilson



Seth Wilson

## ELECTRIC PREDATOR DETERRENT FENCES

There is an array of permanent and temporary electric fence designs that can deter bears and wolves. These fences are used only for small-scale operations, such as beehives, dumpsters, lambing or calving areas, corrals, bone piles and other small areas in need of protection from scavenging or predation.

Permanent fence specifications to deter bears and wolves range from 7-wire to 11-wire fences, 42" to 72" in height. Wires alternate charged and grounded, with both top and bottom wires hot. Table 2 shows a range of specifications developed by the Natural Resources Conservation Service in cooperation with FWP (NRCS 2006b).

Key to the success of electric fences is to erect them before the attractant level is high, so that animals are "trained" to a fence early on. Also, joule rating is crucial. Because of predators' thick fur, the energizer must have an adequate joule rating to deliver enough shock to deter them. Grizzly bears require a minimum of 0.7 joules or more and 6,000

volts. Be sure your energizer can deliver adequate power over the distance you need. In addition, always install warning signs on the fence.

For more complete instructions and recommendations on appropriate designs for your situation, see "Practical Electric Fencing

Top left and right: Predator deterrent fencing should be used only around specific areas, such as corrals and beehives. Always hang warning signs on power fences.

Resource Guide: Controlling Predators" published by the Living with Wildlife Foundation and available online at <http://www.lwwf.org> (Thompson, et al. 2005).

### BEAR AND WOLF DETERRENT FENCING

(Adapted from NRCS 2006B)

#### Charge and Recommended Wire Heights from Ground Level

	Bear <sup>1</sup> 7-wire	Bear & Wolf <sup>2</sup> 7-wire	Beehive <sup>3</sup> 7-wire	Wolf & Bear <sup>4</sup> 9-wire (corral or home areas)	Wolf & Bear <sup>4</sup> 11-wire (away from corral or home areas)
<b>Top wire</b>	(+) 42"	(+) 54"	(+) 54"	(+) 60"	(+) 72"
<b>2nd wire</b>	(-) 36"	(-) 42"	(-) 42"	(-) 50"	(-) 64"
<b>3rd wire</b>	(+) 30"	(+) 32"	(+) 32"	(+) 42"	(+) 56"
<b>4th wire</b>	(-) 24"	(-) 24"	(-) 24"	(-) 36"	(-) 48"
<b>5th wire</b>	(+) 18"	(+) 18 "	(+) 18 "	(+) 30"	(+) 40"
<b>6th wire</b>	(-) 12"	(-) 12"	(-) 12"	(-) 24"	(-) 32"
<b>7th wire</b>	(+) 6"	(+) 6"	(+) 6"	(+) 18"	(+) 26"
<b>8th wire</b>				(-) 12"	(-) 20"
<b>9th wire</b>				(+) 6"	(+) 15"
<b>10th wire</b>					(-) 10"
<b>11th wire</b>					(+) 6"

- Bear<sup>1</sup> (42") 7-wire:** Primary use to deter grizzly and black bears, allows deer and elk passage.
- Bear & Wolf<sup>2</sup> (54") 7-wire:** Primary use to deter grizzly, black bear and wolves from calving and lambing areas, but where wolf activity is low to moderate or there is potential for wolf activity.
- Beehive<sup>3</sup> (54") 7-wire:** Primary use is deter grizzly and black bears from apiaries.
- Wolf & Bear<sup>4</sup> (60-72") 9- or 11-wire:** Primary use is to deter wolves and bears when predator activity or risk is high. Also useful for situations where ungulate damage to a lower fence (54") might be anticipated, or there is a predator issue.



## Getting Help

### Getting Help

**Montana Fish, Wildlife and Parks can contribute information, technical assistance, staff support and small grants to projects that reduce conflicts with wildlife and enhance wildlife habitat on private lands.**

The FWP Landowner/Wildlife Resource Program assists with innovative projects through cost-share with other partners. Other FWP game damage and habitat enhancement programs may also be avenues to find support for wildlife-friendly projects.

Contact FWP Field Services at 406-444-3065 or your local FWP field office.

Natural Resource Conservation Service (NRCS) also offers many cooperative programs that support wildlife habitat enhancement and conservation projects on private lands. For instance, NRCS Montana can currently provide cost-share and technical help to livestock producers and beekeepers to construct non-



Scott Nicolaisen

lethal predator deterrent fences that meet NRCS specifications. NRCS can also provide technical specifications and information for many types of enhancement projects. See <http://www.mt.nrcs.usda.gov/> to learn about the array of NRCS programs, or contact your local NRCS Area Office or Field Office.

MFWP Field Services can help with technical assistance, staff support and small grants on wildlife friendly projects.

In addition, check with your local county extension office for technical assistance and information on other landowner programs. Many sportsmen's clubs and wildlife or land conservation groups may also be interested in helping provide cost-share support or volunteers for wildlife-friendly fencing projects to enhance wildlife habitat.



## Sources

- Allen, G.T. and P. Ramirez.** 1990. A review of bird deaths on barbed-wire fences. *Wilson Bulletin* 102(3):553-558.
- Colorado Division of Wildlife.** 2007. Fencing with wildlife in mind: understanding the impact on wildlife when fencing your property. Colorado Division of Wildlife Living With Wildlife Program. Brochure, 9 pp. Online: <http://wildlife.state.co.us/NR/rdon-lyres/B0D65D61-6CB0-4746-94F1-6EE194E1C230/0/fencing.pdf>.
- George Miksch Sutton Avian Research Center.** 2006. Fence marking for lesser prairie-chickens: a cooperative conservation solution. Sutton Avian Research Center, Bartlesville, OK. 2 pp. Online: [http://www.suttoncenter.org/fence\\_marking.html](http://www.suttoncenter.org/fence_marking.html)
- Gillihan, S.W.** 2000. Barbed-wire fence fatal to burrowing owl. *J. Colorado Field Ornithologists*. 34(4):220-221.
- Harrington, J.L.** 2005. Characteristics of ungulate behavior and mortality associated with wire fences. Master's thesis, Utah State University, Logan, UT. 48 pp.
- Harrington, J.L., and M.R. Conover.** 2006. Characteristics of ungulate behavior and mortality associated with wire fences. *Wildlife Society Bull.* 34(5):1295-1305.
- Karhu, R. and S. Anderson.** 2003. Evaluation of high tensile electric fence designs on big game movements and livestock containment. Final Report April 2003. Wyoming Cooperative Fish and Wildlife Research Unit. Laramie, WY. 27 pp.
- Karhu, R. and S. Anderson.** 2006. The effect of high-tensile electric fence designs on big-game and livestock movements. *Wildlife Society Bulletin* 34(2):293-299.
- Karsky, Dick.** 1988. Fences. Publication #8824 2803. U.S. Department of Agriculture, Forest Service, Missoula Technology and Development Center, Missoula, MT. 210 pp. Second printing 1999. Online: <http://www.fs.fed.us/eng/pubs/pdfpubs/pdf88242803/pdf88242803dpi300.pdf>
- Montana Dept. of Fish, Wildlife and Parks.** 2002. Fencing specifications for FWP properties. Internal document. MT Dept. of Fish, Wildlife and Parks, Helena, MT. October 25, 2002.
- Nero, R.W.** 1974. Great gray owl impaled on barbed-wire. *Blue Jay* 32(3):178-179.
- Nesbitt, S.A. and D.T. Gilbert.** 1976. Powerlines and fences hazards to birds. *The Florida Naturalist*. April: 23.
- North Dakota Game and Fish Dept.** 2006. Pronghorn management guide-2006: Biological and management principles and practices designed to sustain pronghorn populations from Canada to Mexico. North Dakota Game and Fish Department. Online: <http://gf.nd.gov/multimedia/pubs/prong-mgmt-guide-pdf-ndx.html>
- NRCS.** 2006a. Natural Resources Conservation Service Conservation Practice Specification: Permanent Power Fence. Code 382(b)-1 of 5. May 2006. Natural Resources Conservation Service, Wyoming. 7 pp.
- NRCS.** 2006b. Natural Resources Conservation Service General Specification Power Fence. Fence (Feet) Code 382. Specification MT-382 (Power Fence), April 2006. Natural Resources Conservation Service Montana. Online: [http://efotg.nrcs.usda.gov/references/public/MT/382\\_spec\\_Power\\_2006.pdf](http://efotg.nrcs.usda.gov/references/public/MT/382_spec_Power_2006.pdf)
- Patla, S. and D. Lockman.** 2004. Considerations and prescriptions for the design, construction and management of shallow water wetlands for spring through fall use by trumpeter swans (*Cygnus buccinator*) in western Wyoming. Report, Nov. 2004. Wyoming Game and Fish Department, Jackson, WY and Wildlife Services of the Rockies, Cheyenne, WY. 9 pages.
- Quitmeyer, C.J., J.A. Bopp, R.M. Stephens, R. Karhu and S. Anderson.** 2004. High tensile electric fence: phase 2 – liability issues, maintenance costs, and containment of bison. Final Report December 2004. Wyoming Cooperative Fish and Wildlife Research Unit. Laramie, WY. 85 pp.
- Schmidt, L. and J. Knight.** 2000. Electric fencing to control deer and elk on Montana's farms and ranches. Montana State University Extension Service, Bozeman, MT. Online: <http://www.montana.edu/wwwpb/pubs/mt200010.html>
- Thompson, S., J. Jonkel and P. Sowka.** 2005. 2005 Edition Living with Predators Guide. Practical Electric Fencing Resource Guide: Controlling Predators. Living With Wildlife Foundation, Swan Valley, MT. 38 pp. Online: <http://www.lwwf.org>
- Washington Dept. of Fish and Wildlife.** 2004. Make your fence wildlife friendly. Crossing Paths Newsletter, Fall 2004.
- Wyoming Game and Fish Dept.** 2004. Fencing guidelines for wildlife. Revised version Habitat Extension Bulletin No. 53. Wyoming Game and Fish Dept. 12 pp.

For more information or assistance, contact your local FWP office, wildlife biologist, or warden.

Joe Weigand, Landowner/Wildlife Resource Specialist, can also be reached at (406) 444-3065, or email [joweigand@mt.gov](mailto:joweigand@mt.gov).



donaldmjones.com



*Montana Fish,  
Wildlife & Parks*

1420 East 6th Avenue • PO Box 200701  
Helena, MT 59620-0701

Printing of this document was funded with sportsmen's license dollars.  
Information regarding print costs can be obtained by writing to Montana Fish, Wildlife and Parks.