

TECHNICAL NOTES

U.S. DEPARTMENT OF AGRICULTURE NATURAL RESOURCES CONSERVATION SERVICE

FOREST

SPOKANE, WASHINGTON

ENGINEERING #10

November, 2007

Forest Road Contracting, Construction, and Maintenance for Small Forest Woodland Owners

by

Brian W. Kramer

Research Contribution 35

Oregon State University

College of Forestry

Forest Engineering Technical Note # 10 is provided to aide in designing, constructing, and maintaining forest roads.

Research Contribution 35

**FOREST ROAD CONTRACTING,
CONSTRUCTION, AND
MAINTENANCE FOR SMALL
FOREST WOODLAND OWNERS**

by

Brian W. Kramer

November 2001



OREGON STATE
UNIVERSITY
COLLEGE OF
FORESTRY

Forest Research Laboratory

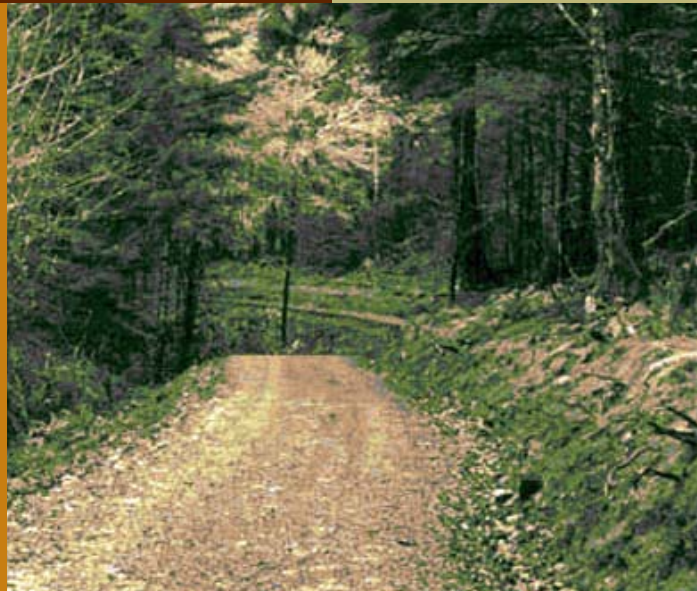

The Forest Research Laboratory of Oregon State University, established by the Oregon Legislature, conducts research leading to sustainable forest yields, innovative and efficient use of forest products, and responsible stewardship of Oregon's resources. Its scientists conduct this research in laboratories and forests administered by the University and cooperating agencies and industries throughout Oregon. Research results are made available to potential users through the University's educational programs and through Laboratory publications such as this, which are directed as appropriate to forest landowners and managers, manufacturers and users of forest products, leaders of government and industry, the scientific community, the conservation community, and the general public.

THE AUTHOR

Brian W. Kramer, P.E., is a Senior Instructor in the Department of Forest Engineering, Oregon State University.

ACKNOWLEDGMENTS

The publication of this handbook was made possible with significant contributions from Forest Service Employees for Environmental Ethics. We also thank the Northwest Fund for the Environment and the National Woodland Owners Association for their significant financial support.

DISCLAIMER

The mention of trade names or commercial products in this publication does not constitute endorsement or recommendation for use.

TO ORDER COPIES

Copies of this and other Forest Research Laboratory publications are available from:

Forestry Communications Group
Oregon State University
256 Peavy Hall
Corvallis, Oregon 97331-5704

Phone: (541) 737-4271

FAX: (541) 737-4077

email: forspub@cof.orst.edu

Web site: <http://www.cof.orst.edu/cof/pub/home/>

Please indicate author(s), title, and publication number if known.

Editing, word processing, design, and layout by Forestry Communications Group.



Research Contribution 35

November 2001

**FOREST ROAD CONTRACTING,
CONSTRUCTION, AND MAINTENANCE
FOR SMALL FOREST WOODLAND
OWNERS**

by

Brian W. Kramer

This handbook is dedicated to the small private forest woodland owners of the Pacific Northwest for their significant contribution to the timber industry.



**OREGON STATE
UNIVERSITY**

**COLLEGE OF
FORESTRY**

Forest Research Laboratory



ABSTRACT

Kramer, Brian W. 2001. *Forest road contracting, construction, and maintenance for small forest woodland owners*. Research Contribution 35, Forest Research Laboratory, Oregon State University, Corvallis.

This handbook is a comprehensive guide to building and maintaining cost-effective, environmentally acceptable logging roads. It is aimed specifically at nonindustrial private woodland owners in western Oregon and Washington, but it draws on basic forest road engineering principles and practices applicable in other forestry settings. The text is written, as much as possible, in nontechnical terminology for those forest landowners who may have little or no road engineering knowledge. Two types of forest roads, ditched and outsloped roads, are addressed in detail. The construction and maintenance of all-weather and dry-season roads is presented. Information is provided to assist the landowner in writing successful forest road construction, reconstruction, and maintenance contracts.

CONTENTS

INTRODUCTION	5
CHAPTER 1 OVERVIEW OF FOREST ROADS: PARTS AND NOMENCLATURE	7
CHAPTER 2 DITCHED ROADS	14
CHAPTER 3 OUTSLOPED ROADS	19
CHAPTER 4 ROAD CONSTRUCTION AND RECONSTRUCTION	24
CHAPTER 5 ROAD LOCATION AND SURVEY	43
CHAPTER 6 FOREST ROAD MAINTENANCE	47
CHAPTER 7 HOW TO WRITE A SUCCESSFUL CONTRACT TO CONTROL ROAD CONSTRUCTION AND RECONSTRUCTION	54
APPENDIX A STANDARD ROAD CONSTRUCTION AND RECONSTRUCTION TEMPLATES	66
APPENDIX B LICENSED FOREST ENGINEERS	75
GLOSSARY	77

INTRODUCTION

The information in this handbook, drawn from the author's 30 years of forest road engineering experience and his unpublished notes, is for forest landowners who have little or no road engineering experience. The goal of this handbook is to introduce landowners to the major aspects of road location, construction, and maintenance, and to provide the basic knowledge necessary to successfully contract for road construction and reconstruction operations that are cost effective, environmentally friendly, and otherwise meet the needs of the landowner.

It is suggested that the landowner consult a reliable professional forest engineer when writing the road section of a timber harvest contract, and especially for any of the more complex aspects of road construction, such as planning for stream crossings and locating a road on difficult terrain. You can often find direction for this assistance at regulatory forest practice agencies (ask your county Extension forester). Part of the goal of this handbook is to give landowners, when constructing roads on their land, basic tools and knowledge to ask informed questions of contractors and engineers.

Why is this important? Forest roads often represent a significant investment for forest landowners. Forest roads also potentially add more sediment to streams than any other forest operation; forest roads can also inhibit fish passage and disrupt wildlife. Landslides can be caused by inadequate road location, construction, and maintenance, and can have a catastrophic effect on stream environments. Over time, effectively constructed and maintained forest roads can save the landowner money on road maintenance and provide better protection for the environment.

What is meant by an effectively constructed and maintained road? As described within, a forest road should have properly constructed and carefully maintained roadway drainage and adequately compacted road fills and surfaces. Proper drainage directs and carries water off the roadway quickly and in short intervals along the length of a road before the runoff can accumulate and cause significant erosion and possibly dump road sediments into streams. A road that is adequately compacted with a suitable road building material will slow the penetration of moisture and decrease the amount, or volume, of moisture that can enter a given volume of roadway subsurface. This in turn can reduce rutting and prevent slumping, or sliding failure, of roadway fills. An effectively constructed road must also be properly located to meet the landowner's needs and to minimize construction costs, maintenance, and environmental damage.

Within are described in detail two types of low-speed, low-traffic-volume, single-lane forest roads: ditched roads (insloped and crowned) and outsloped roads without ditches.

More complex and expensive two-lane forest roads are not discussed because they are beyond the scale of most small woodland operations. Though outsloped roads are not as common as ditched roads, they can be more cost-effective and less environmentally damaging than ditched roads.

Why are outsloped roads uncommon today? In general, many involved in forest road construction don't completely understand the function of outsloped roads, and lack knowledge of how to properly construct and maintain this type of road. Prior to the development of efficient mechanical earthmovers and tractors and the advent of relatively inexpensive concrete and corrugated steel culverts in the 1930s, many forest roads were constructed without ditches. These roads had outsloped road surfaces that drained the road surface runoff across and off the road surface at every point along a road. This type of road can be ideal for small private forest landowners because they are less expensive to construct and maintain than ditched roads. Properly located, constructed, and maintained outsloped roads also yield less turbidity and dump less sediment into streams. Roadway maintenance is less expensive on outsloped roads compared with ditched roads because there are no ditches and ditch relief culverts to maintain.

Nevertheless, as will be seen in Chapter 2, outsloped roads are not appropriate for every situation, and because ditched roads are more common, it is important that the landowner be familiar with both types of construction.

To guide the reader through the various aspects of forest roads, this book is organized in seven sections. Chapter 1 provides a broad overview of forest roads and their various components. Chapter 2 discusses ditched roads, while Chapter 3 explores the advantages and components of outsloped roads. Chapter 4 presents road construction techniques, including preparing the road bed and road surface, setting grades and curves, as well as a brief lesson in soils. Chapter 5 provides a basic overview of road location and surveying methods, and Chapter 6 discusses the essentials of proper road maintenance. Chapter 7, perhaps the book's most important section, finishes with suggested language for writing a successful road section of a timber sale contract that meets the landowner's needs and protects the environment. The Appendix includes a glossary of terms, as well as a set of drawings that can be copied or modified and used in a landowner's timber sale or road contract.

OVERVIEW OF FOREST ROADS: PARTS AND NOMENCLATURE

INTRODUCTION

This chapter begins by providing an overview of the component parts of forest roads, as well as an introduction to the different types of roads that can be constructed. The latter sections preview the remaining chapters in this book.

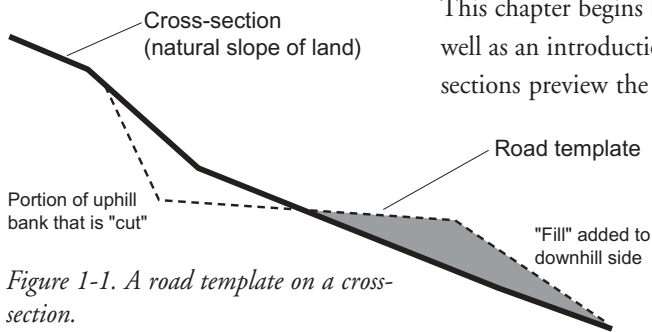

Figure 1-1. A road template on a cross-section.

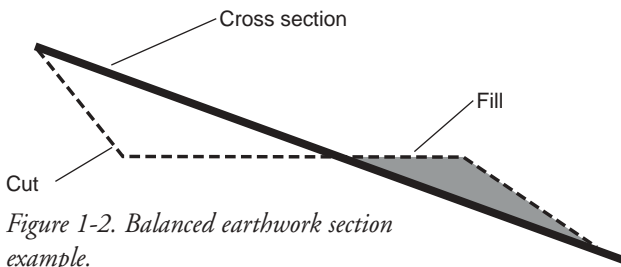
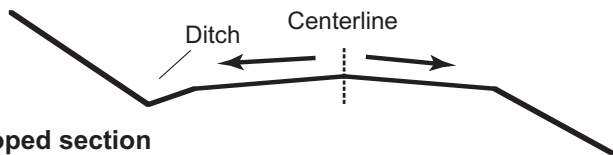
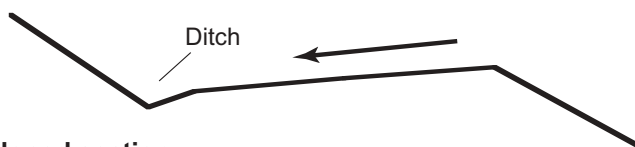

Figure 1-2. Balanced earthwork section example.

Crowned section



Insloped section



Outsloped section

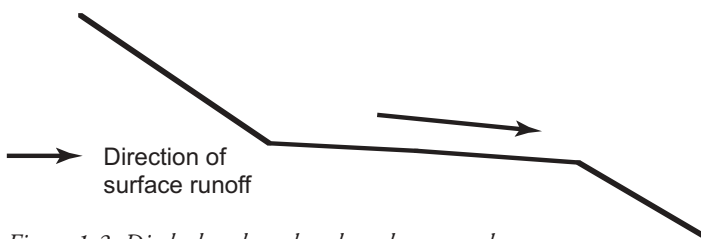

Figure 1-3. Ditched and outsloped roadway templates.

CROSS-SECTIONS AND ROAD

Cross-sections are the natural ground profile perpendicular to the road; they show the slope and angle of topography at any given point. A road template shows the shape of a road set on the cross-section—that is, set on the slope of the natural ground (Figure 1-1).

Common to most cross-sections are the cut and fill sections of the road, where the “cut” is the portion of the uphill bank that is removed, and the “fill” is where material has been added to and compacted on the downhill side of the road. Road sections are considered “balanced” when the volume of earth cut equals the volume of compacted fill (Figure 1-2).

ROAD SURFACE GEOMETRY (CROWNED, DITCHED, AND OUTSLOPED ROADS)

A road surface is sloped to rapidly shed surface runoff water. There are three basic types of forest road surfaces to accomplish this: crowned, insloped, and outsloped roads (Figure 1-3). The crowned road surface shown in Figure 1-3 carries surface runoff to both sides of the road. Insloped roads carry water to the interior (or uphill side) of the roadway and thus are constructed with a ditch and ditch relief pipe culverts to channel water under the roadbed and remove runoff to the downhill side of the road. Outsloped roads shed runoff to the outside and generally do not have a ditch on the inside.

Because two-lane roads are beyond the scale of most small woodland operations, the two types of roads that will be addressed in this book are the single-lane road with a ditch and the outsloped road without a ditch (Figures 1-4 and 1-5).

Currently, ditched roads are the most common industry-wide in the Pacific Northwest, though outsloped roads have several distinct advantages for lowering the cost of construction and maintenance and lessening the impact on the environment. Outsloped roads are not, however, appropriate for every situation. We'll look closely at each type and where they are best used in Chapters 2 and 3.

Both insloped and outsloped roads can be surfaced with rock (aggregate) or with native soil surface, depending on specific road use requirements, such as the season when logging will occur. Wet-season logging generally requires an all-weather rock surface. Both ditched and outsloped roads have common elements; the only exception is roadway surface drainage.

The type of material (aggregate rock or native soil surface) used on a road surface depends on several factors:

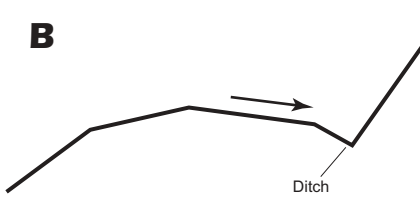

Figure 1-4. Photo (A) and diagram (B) of road with a ditch.

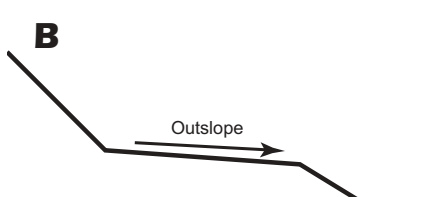

Figure 1-5. Photo (A) and diagram (B) of an outsloped road without a ditch.

- *Season of use.* Roads in use only during dry seasons might not need any road surfacing. The native soil subgrade surface may be adequate, depending on the quality of the soil and the season of log haul. All-weather roads are used during the wet and dry seasons. These roads usually require rock surfacing to be used during the wet season.

- *The quality of subgrade material at the site.* The subgrade is the foundation of the road surface. The stronger the subgrade material, the less surfacing rock required. Rock subgrade may not require any surfacing. Soil subgrade will require crushed rock surfacing for log hauling during periods of wet weather.

3. *The quality of the rock aggregate to be added.* The quality of road sur-

facing rock is related to the durability and strength of the aggregate. The angularity, size, and percent distribution of crushed particle size is also important in determining how well the rock aggregate “locks” into place.

- *The amount of vehicle traffic.* The road surface is worn with every vehicle passage. Road surface wear is directly related to vehicle weight and number of vehicles traveling over a given section of road. On native-soil and aggregate-surfaced roads, this action grinds the surface soil or aggregate particles together, which wears the soil or rock. With each vehicle passage, the surfacing is compressed, causing rutting. This process is slowed with a stronger road surface and less vehicle traffic.

TYPES OF ROAD SECTIONS

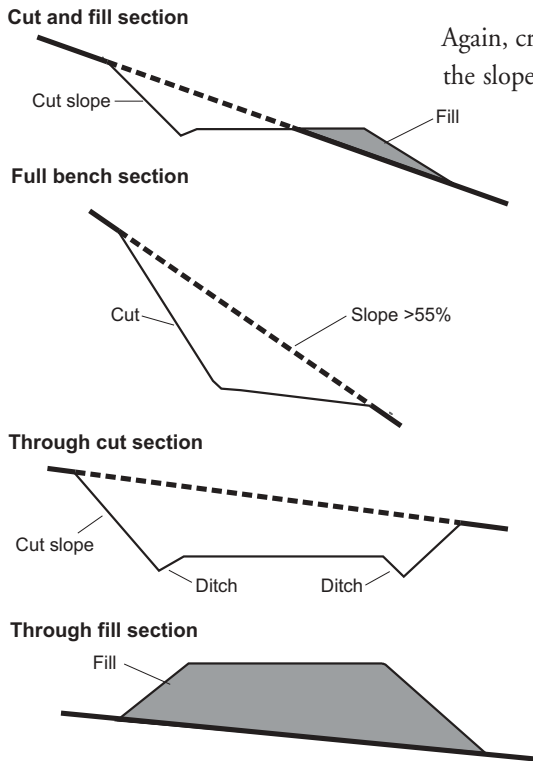

Figure 1-6. The types of road sections.

Again, cross-sections are the natural ground profile perpendicular to the road; they show the slope and angle of topography at any given point. A road template shows the shape of a road set on the cross-section—that is, set on the slope of the natural ground. In addition to the three basic types of road surfaces (crowned, insloped, outsloped), there are four general types of road sections: cut and fill, full bench, through cut, and through fill (Figure 1-6).

The cut and fill section, perhaps the most common type of road section, can be used on ground up to 55% cross-section slope. The full bench section is generally used on cross-section slopes greater than 55%. The through cut section is used where the ground must be cut through to avoid an overly steep road grade, such as on a steep hill crest. The through fill section is used to cross streams, draws, wet or swampy ground, and often on especially flat terrain where water is likely to sit.

PARTS OF THE ROAD

General road nomenclature for the various road elements are identified and illustrated in Figure 1-7. Though this example shows a cut and fill section, this general nomenclature applies to most road types.

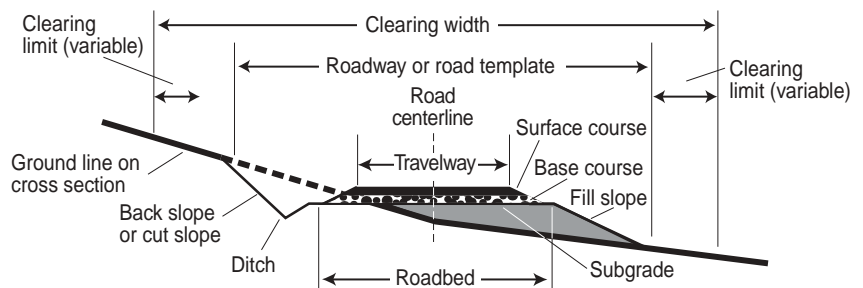

Figure 1-7. Road element terminology.

CUT AND FILL SLOPES

A newly constructed cut and fill slope is shown in Figure 1-8.



Figure 1-8. Example road cut and fill slope.

The cut and fill slope angles on a road are expressed as a ratio of the horizontal distance to the vertical distance of the slope. Road cuts and fill banks should be constructed to slope angles that minimize slope failure and raveling (erosion of the cut and fill slopes). Figure 1-9 shows possible examples of cut and fill slopes that could work for a native-soil-surfaced road section with a downslope fill of common material. The roadway cut slope is expressed as the ratio 1:1; that is, the slope is on an angle with a horizontal distance of 1 foot and a vertical distance of 1 foot (or 45 degrees). The fill slope ratio is 1.3:1, where the slope angle has a ratio of 1.3 feet horizontal to 1 foot vertical (or 37 degrees).

Depending on the soil and rock type encountered, cut and fill slopes are constructed to different slope ratios. Table 1-1 illustrates example slope ratios for various rock and soil types.

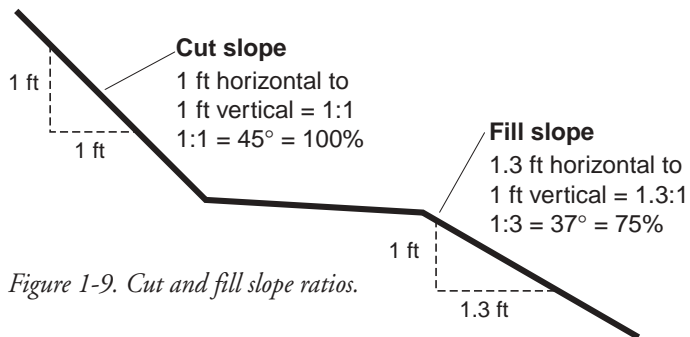

Figure 1-9. Cut and fill slope ratios.

Table 1-1. Cut and fill slope ratio types.

Soil type	Cut	Fill
Common soil	1:1	1.5:1
Clayey soil	2:1–3:1	N/A*
Solid rock	0.5:1	N/A**
Fractured rock	0.75:1	1 ¹ / ₄ :1

*Clayey soils do not provide for adequate subgrade materials as they tend to hold moisture and do not drain.

**Solid rock is not used in constructed fills.

ROAD LOCATION

Timber harvest and transportation planning is necessary to assure cost-effective and environmentally sound harvests and to anticipate road access for future timber management. The amount of planning necessary depends on the terrain, size of the management area, volume of timber to be harvested, potential harvest methods, existing roads, and environmental regulations, among other factors.

Road location, which will be discussed in more detail in Chapter 5, is the foundation of a road. Forest roads should be located on stable ground. By doing this, not only will

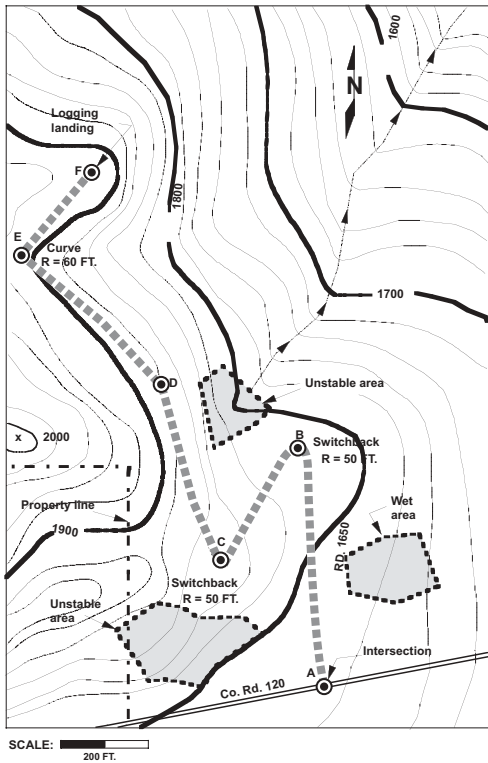

Figure 1-10. Example road location map with the road located through sensitive areas.



Figure 1-11. Example of a poor road location, causing a roadway slump failure.

there be less damage to the environment, but the road often requires less maintenance and is less costly.

In difficult terrain, a landowner may want to hire a professional forest engineering consultant to assist in preparing a timber harvest and transportation plan. The Appendix lists professional forest engineering firms located in the Pacific Northwest. At a minimum, the landowner should provide the logging contractor a written harvest plan—part of a contract—that documents road location, the boundaries of harvest units, and the type of roads to be constructed. The harvest plan should also establish the specific elements (components) of the roads and standards for their construction (we will cover road contracts in detail in Chapter 7). Figure 1-10 illustrates an example of a road location through sensitive terrain to a designated harvest log landing. Notice that the road is carefully located to fit the terrain and to avoid wet and unstable areas.

An optimum road location avoids critical topography such as wet ground, unstable areas, and locations adjacent to streams. If a road must be located on critical topography, landowners may again need the assistance of a professional forest engineer. Direction for this assistance can be found at regulatory forest practice agencies, or from your county Extension forester. A road located and constructed on unstable ground is shown in Figure 1-11. This section of road might become a continual maintenance problem and an ongoing expense. It could also harm the environment by displacing soil into a nearby stream.

Of particular importance to road planning are road grade, the radius of horizontal curves, the length of vertical curves (uphill and downhill grade changes), stream-crossing sites, road intersections, and timber harvest equipment landings. These will be discussed in depth in Chapter 4.

The road should also be located to accommodate the logging vehicles that must use the road. The largest vehicles are usually the log truck or tractor-trailer combination (Figure 1-12). The tractor-trailer is used to transport road building and logging equipment to and from a road construction or logging project, whereas the log truck is used to transport harvested logs. Some roads are designated only for log trucks. Tractor-trailer units may not be able to negotiate the road. Equipment that must be carried on a tractor-trailer and operates on this type of road is unloaded and driven or “walked in” to where it will be used.

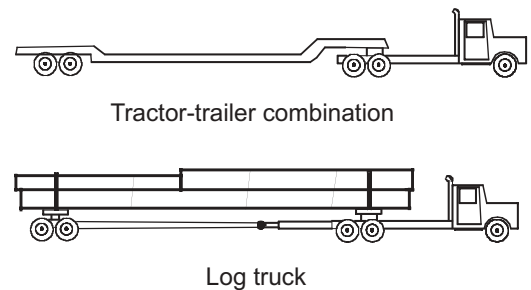

Figure 1-12. A log truck and a tractor-trailer.

ROAD GRADE AND CURVES

In general, road grades need to be a minimum of 2% to facilitate drainage, so that water doesn't sit in ruts and ditches and possibly saturate the subgrade. There are also maximum grades for logging vehicles, as well as minimum curve dimensions (both horizontal and vertical) to allow vehicle passage. Chapter 4 will explore road grade and curves in more detail.

ROAD MAINTENANCE

Effective road maintenance can also be critical in preventing significant repair costs and in minimizing environmental damage. The key to a long-lasting road is proper location, construction, access control, and timely periodic maintenance.

To avoid the environmental and monetary costs of erosion, road surfaces should be maintained to channel road surface runoff in the shortest practical distance. Roadway drainage structures such as culverts should be kept clear of debris and in good repair. Ditches should be clear of debris to prevent standing water and ditch blockage. Vehicle access may need to be controlled during the wet season to prevent damage to the road surface. It is especially important that vehicle access be controlled on dirt-surfaced roads during wet periods. All of these issues will be addressed in Chapter 6.

THE CONTRACT: ESTABLISHING ROAD ELEMENTS AND STANDARDS FOR FOREST ROADS

Chapter 7 will discuss in detail ways to write contract language to the landowner's advantage. To begin with, the landowner should establish a written contract that provides contractors with necessary "road elements" and "road standards." The elements are the various parts of the road, such as its subgrade and surface, and the cut and fill of the cross-slope above and below the road. The standards are simply the established dimensions or material specifications of the road elements. These standards include the width of the road's subgrade and surface, the slope of the cut and fill, and the depth and size of the base and surface rock. Table 1-2 illustrates generally applicable road elements and standards that might be used in a contract for an all-weather forest road.

Table 1-2. Example road elements and standards.

Road elements	Road standards
Road subgrade width	14 ft
Road surface width	12 ft
Fill slope ratio	1.5:1
Cut slope ratio	1:1
Base rock depth	6.0 inch minus, 6 inch deep
Surface rock	2.0 inch minus, 2 inch deep

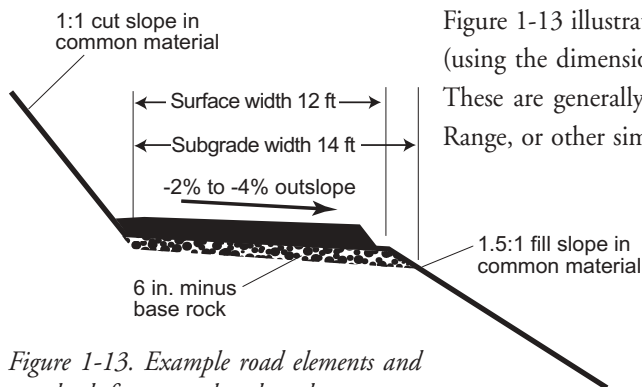

Figure 1-13. Example road elements and standards for an outsloped road.

Figure 1-13 illustrates an example of road elements and standards for an outsloped road (using the dimensions from Table 1-2) that a landowner might use in a road contract. These are generally suitable for all-weather outsloped roads located in Oregon's Coast Range, or other similar climates.

Note that the "minus" in Table 1-2 and in Figure 1-13 indicates that the size of the largest individual pieces of rock will be equal to the dimensions given (6 inches and less for base rock and 2 inches and less for surface rock). The thickness of the layer on the road is measured after compaction.

PROPER CONSTRUCTION AND ROAD LOCATION IN A ROAD CONTRACT

The logging contractor or the logger's road construction subcontractor generally constructs forest roads for private landowners. Landowners should clearly set a contract for road construction and road maintenance during harvest operations to assure that the road meets their current and future needs. The contract should address at least the following items:

- Type of road to be constructed (a ditched road or an outsloped road without a ditch)
- Initial clearing of the road corridor
- Placing and compacting of excavated material
- Type and method of road subgrade and surface finishing (tied to the logger's operating season)
- Type, grade, and placement of drainage structures such as ditches and relief culverts
- Stream-crossing and road drainage structures for fish passage, if required
- Road location (either direct or survey and office design), as well as established minimum/maximum grades and minimum/maximum curve lengths
- Road maintenance during logging operations (including erosion and access control)
- Final road restoration after logging
- Applicable state and federal regulations

Chapter 7 will offer specific advice for creating road contracts that are financially and environmentally sound.

Ditched forest roads became common in the 1930s when bulldozers were first effectively used to excavate roadways. With a ditched road, the surface template is either crowned or insloped (or outsloped on inside curves) to direct road surface drainage to the ditch (Figure 2-1). The ditch routes runoff away from the road through ditch relief culverts. In contrast, outsloped roads seldom require ditches or relief culverts. In some cases, an under-drain and a ditch will be used on an outsloped road where the road interrupts groundwater

flow. In addition, ditched roads can have outsloped sections in inside curves. However, the majority of ditched roads will either be insloped or crowned.

On a crowned section, half the surface runoff runs to the outside shoulder and half to the ditch. On insloped road sections, all the road surface drainage is channeled to the ditch. On outsloped road sections, all the road surface drainage is channeled to the outside road edge.

Though less common, outsloped roads, because of their type of drainage, have some distinct advantages in terms of reduced construction and maintenance costs and lessened impacts on the environment (as we shall see in Chapter 3). Ditched roads can require significantly more excavation of the uphill slope to allow for the ditch, as well as the additional cost of relief culverts and downspouts to drain ditch water safely away from the roadbed. This can add substantially to construction costs. Ditched roads also require continual maintenance of the ditch and its drainage systems. Concentrating runoff in the ditch gathers and increases the erosive and destructive power of the water and the amount of sediment it can carry into nearby streams, whereas outsloped roads shed runoff water at each point along the road surface so that it is less likely to gather erosive force. Both ditched and outsloped roads must have the road surface maintained, with ruts removed, to maintain adequate road surface drainage.

Because ditched roads are more common and more appropriate in certain situations, landowners should have basic knowledge of their construction. The advantages and disadvantages of ditched versus outsloped roads will be further explored in Chapter 3.

ROADWAY DRAINAGE DITCHES

Ditches intercept road surface runoff, overland surface runoff, and a certain amount of subsurface water. The ditch grade should be at the road grade and a minimum of 2% or

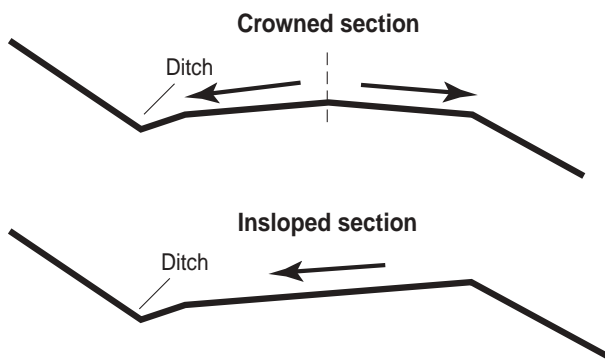

Figure 2-1. Types of ditched road surfaces.

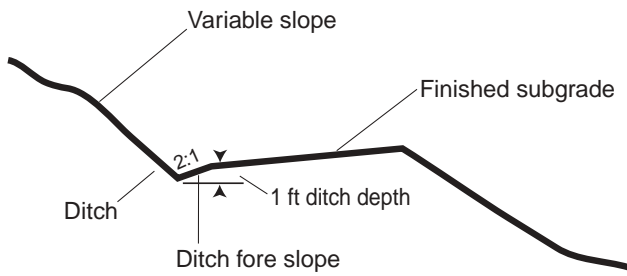

Figure 2-2. Example ditch dimensions.

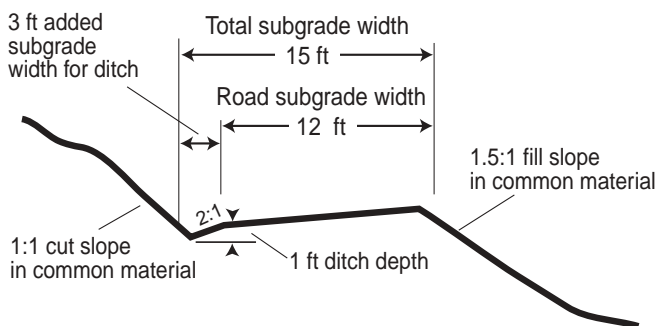

Figure 2-3. Example of ditched native-soil-surfaced road standards.

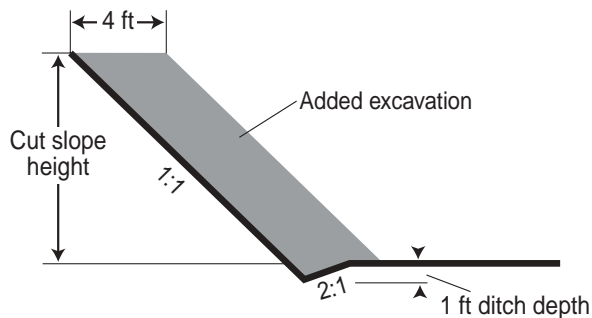

Figure 2-4. Added excavation of a ditched road as compared to an outsloped road.

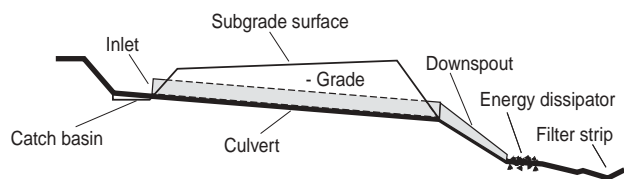

Figure 2-5. Ditch relief culvert sketch.

water can stand in the ditch and saturate the subgrade, possibly causing potholes or road fill failure. The damage can occur in at least two ways. If the subgrade becomes saturated, which occurs especially in less compacted road fills with relatively large air voids, the fill slope can weaken and slough off. Also, a relatively flat ditch can become easily blocked, forcing water onto the road grade and eroding the road surface and fill slope.

The example ditch dimensions in Figure 2-2 show a minimum of 1 foot depth with a minimum ditch fore slope of 2:1 (the fore slope is the side of the ditch toward the road).

Ditches should not drain directly into stream channels because they can pollute the stream with sediment runoffs. Instead, ditch water runoff should be intercepted periodically by relief culverts to carry water across the road to the outside fill slope. In addition, a culvert should be placed just before the stream to carry away final ditch runoff. A filter area of vegetation should be established between the culvert outlet and the stream channel to catch the sediment from relief culvert discharge before the water enters a stream channel. When possible, roads should be constructed as far away from streams as practical. If it is necessary to build a road near a stream, check with your state forest practices forester for advice on drainage, filter strips, and stream-crossing structures.

Example road element standards are illustrated in Figure 2-3 for a single-lane, ditched road. Total roadway width is 12 feet for the roadway plus 3 feet for the ditch width, for a total width of 15 feet.

For a ditched road, the additional width of the cut slope to accommodate the ditch can require substantially more excavation than does an outsloped road with the same subgrade width and cut and fill slope ratios (Figure 2-4).

DITCH RELIEF CULVERT SPECIFICATIONS

Ditch relief culverts carry roadway runoff from the ditch, transport it beneath the road, and discharge the water safely away from the road (Figure 2-5). Below the culvert's discharge point, a vegetated filter strip helps to dissipate the energy of the falling water and allow suspended sediment to settle. In some cases an energy

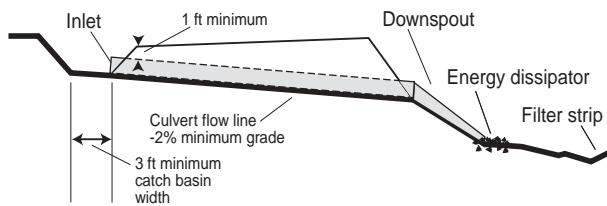

Figure 2-6. Minimum dimensions for ditch relief culvert installation.

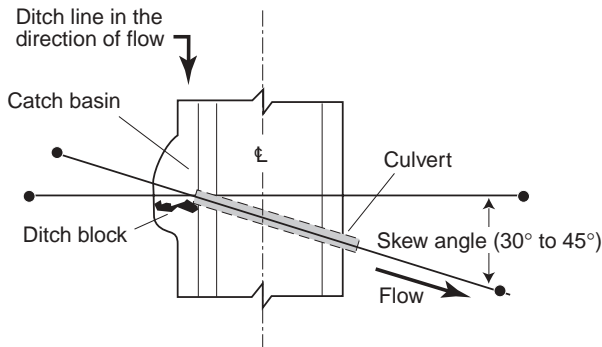

Figure 2-7. Aerial view of a ditch relief culvert installation.



Figure 2-8. Erosion caused by a culvert in need of a downspout.

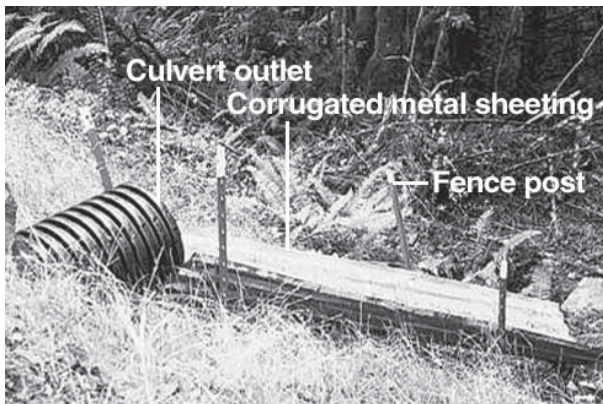

Figure 2-9. A ditch relief culvert with a downspout of corrugated metal roof sheeting.

dissipater of piled rock or woody material is added to disperse the falling water's energy to prevent erosion of the fill slope.

The following dimensions for installing relief culverts assure that a culvert will function adequately, if properly maintained (Figure 2-6). The minimum fill over the top of a ditch relief culvert inlet is 1 foot at the subgrade ditch's shoulder for all culvert material types and diameters. A catch basin in the ditch is necessary to channel the water from the ditch into the culvert inlet. To allow access for cleaning, the catch basin should be constructed with a minimum bottom width of 3 feet. The culvert should have a minimum of a -2% slope in the direction of flow to prevent sediment and debris from accumulating inside the culvert barrel (Figure 2-6).

Fill material used to backfill a culvert trench should be common material or crushed aggregate, which is the soil from which the road is constructed, free of organic debris, large rocks, clay, snow and ice. The fill material in the culvert trench should be compacted. If not, the fill will settle over time, causing a dip in the road surface over the filled culvert trench. Rocks over 3 inches in diameter should be excluded from the fill within 1 foot of the culvert in the trench. This is done to avoid denting or puncturing the culvert.

Relief culverts should be skewed 30 to 45 degrees across the road to efficiently channel water into the culvert entrance (Figure 2-7). A rock or common soil ditch block below the culvert is necessary to prevent runoff from continuing down the ditch line past the culvert inlet. Rock is less likely to erode than a soil ditch block.

Culvert outlets that discharge onto common fill material (that is, onto an area without rocks or other energy dissipaters) can seriously erode the roadway (Figure 2-8) and pollute streams.

When culvert outlets are located in fills above natural ground, a downspout should be added to channel the water away from the fill slope. Downspouts can be constructed of a half-round culvert section attached below the outlet of a relief culvert outlet. Relatively inexpensive short downspouts can also be constructed from secondhand corrugated sheet metal roofing, supported by four steel fence posts driven into the ground, with galvanized wire to attach the roofing material to the culvert outlet and the fence posts (Figure 2-9).

To help disperse the erosive energy of the falling water, energy dissipaters can be installed below the downspouts. Rocks or old slash logs



Figure 2-10. Downspout with corrugated metal roof sheeting, with slash logs for energy dissipation.

are commonly used; see Figure 2-10.

The proper size, spacing, and installation of relief culverts are all key to effective roadway surface drainage. There is little local information published on the spacing of ditch relief culvert locations. Culvert spacing is usually determined by local conditions.

Culverts are constructed of galvanized corrugated steel, corrugated aluminum, concrete, or plastic high-density polyethylene (HDPE). Steel is the strongest, heaviest, and most susceptible to corrosion. Aluminum is resistant to corrosion in most acidic soils. It is lighter than steel but not as strong, and heavier and stronger than plastic. Plastic HDPE is lighter than aluminum and very corrosion resistant, not as strong as aluminum, and susceptible to fire. Plastic has become a popular culvert material because one person can handle the 20-foot by 18-inch pipe sections and because it is easily cut to length for fabrication. A single person operating a backhoe can install plastic HDPE relief culverts.

For forest roads, relief culverts are commonly 12, 15, and 18 inches in diameter. Selecting a culvert diameter depends on a number of factors. Lower-diameter culverts are less expensive and easier to handle. However, 12-inch diameter culverts are difficult to clean out and keep free of obstructions. Unlike larger-diameter culverts, the inlets of 12-inch culverts cannot be cleaned out with a shovel. Also, the smaller the culvert diameter, the less water it will carry. Thus, for a given road grade, 12-inch culverts should be spaced closer together than 15- or 18-inch culverts to accommodate the same ditch flow.

There are five factors to consider when determining the spacing of relief culverts:

- The location on the hill (the lower the road is located on the hill slope, the more ground surface runoff the road's ditch will intercept)
- Local rainfall intensity
- Type of soil used to construct the ditch
- Road grade
- Culvert diameter

There is little documented engineering data that will tell the landowner site-specific culvert spacing information. The greater the local rainfall intensity, the steeper the road grade, and the more erosive the soil, the closer relief culverts should be spaced. For example, on steep road grades, say 10%, with highly erosive soils and high precipitation, relief culverts might be necessary every 200 feet. On a road location with a lower grade, say 4%, with ditch soil that is not highly erosive and low precipitation, adequate culvert spacing could be set at 800 feet. Again, however, these are not hard and fast numbers. An expe-

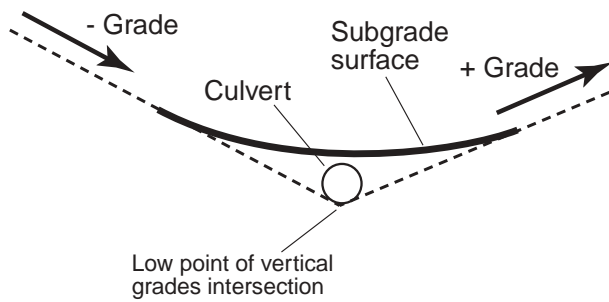

Figure 2-11. Ditch relief culvert installed at the low point in the ditch line.

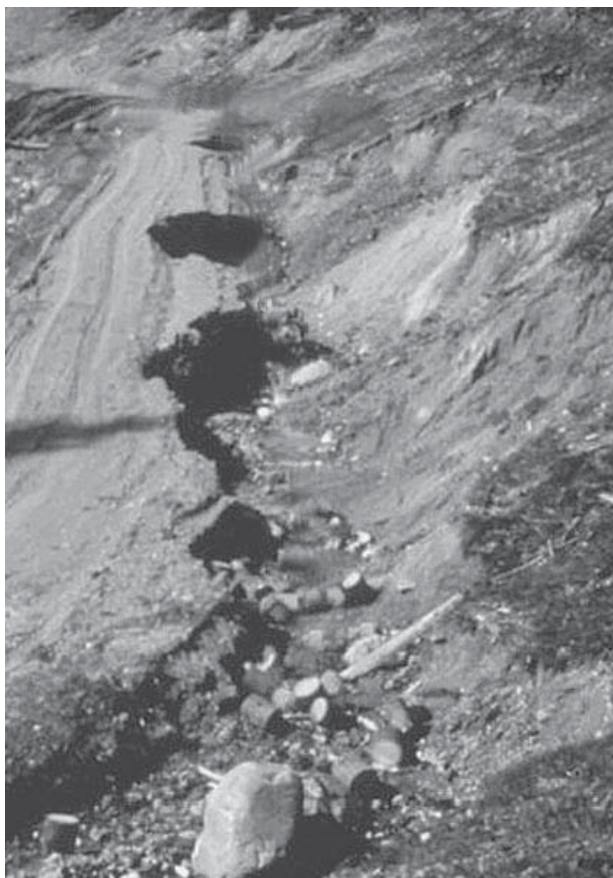

Figure 2-12. Serious erosion caused by blocked ditch relief culverts.

rienced road engineer can offer valuable advice, as can your state forest Extension service or state Department of Forestry. To help determine appropriate spacing between culverts, landowners can also examine the forest roads in their immediate area to determine what worked and what didn't work for similar grades, soils, and road types.

Relief culverts should also be installed at the low points in a ditch line (Figure 2-11). If they are not, water will collect in these low points. Without a relief culvert, the trapped water can migrate into the subgrade, causing potholes or saturating the fill and causing erosion or slump failure.

Roadway ditches and relief culverts should be properly installed and receive periodic maintenance to avoid failure during periods of heavy precipitation (see also Chapter 6 on road maintenance). Ditches and relief culverts not properly maintained during periods of heavy precipitation can cause considerable erosion damage. Figure 2-12 shows serious roadway erosion caused by blocked culvert inlets. As we shall see in the following chapter, this is one reason a landowner might consider an outsloped road.

Outsloped roads were common before tractors began to be used for roadway construction and before the availability of relatively inexpensive corrugated steel pipe for ditch relief culverts. Outsloped roads minimize excavation and cost because they are constructed to drain surface runoff without the need for ditches and relief culverts (see Figure 2-4 from the previous chapter). Outsloped roads are often called “minimum impact” roads as compared to ditched roads. A properly located, constructed, and maintained outsloped road generally yields less runoff turbidity and erosion than a ditched road on the same location. The ditched road channels concentrate larger volumes of water in the ditch than does an outsloped road that does not concentrate the runoff in a ditch. Road construction and maintenance costs would also be less for the outsloped road.



Figure 3-1. A full bench outsloped road section on a 70% slope.

Outsloped roads are not appropriate for every situation. For example, on steep grades during winter use in snow zones, trucks can tend to slide to the outside of the roadway on an outsloped road. When a cutbank ravel, the slough is in contact with the road surfacing and can contaminate the surface rock (as opposed to eroding into the ditch on an insloped road). In addition, the ravel can narrow the road unacceptably, and when graded off it can undermine the slope of the cut bank, causing more ravel problems. Care must be taken when removing slough in order to keep this problem to a minimum; soil particles can lubricate road surface rock particles when they are wet and lower their adhesive properties (the bonding strength of the surface rock). Cutbank slough should be periodically cleaned so it won't contaminate more of the road surface aggregate. In general, outsloped roads also lower the maximum speed because vehicles at excessive speeds or slippery conditions tend to slide to the outside of the roadway.

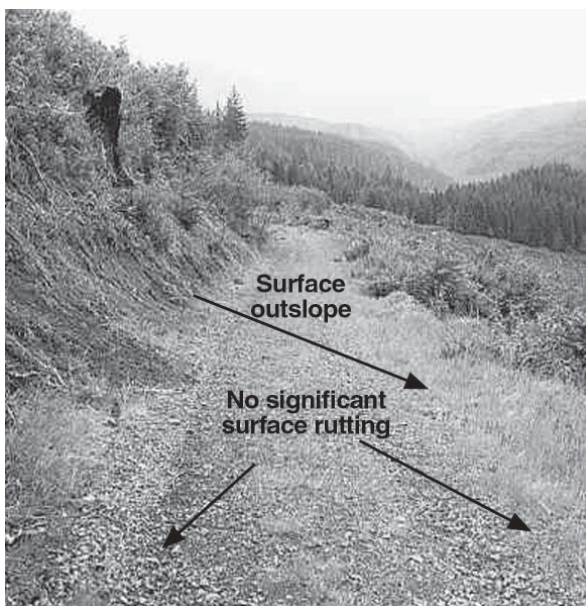

Figure 3-2. Minor cut bank sloughing on an outsloped road after a serious storm.

Sometimes it is advantageous to convert a ditched road to an outsloped road to reduce future maintenance costs. To do this, the ditches must be filled, the relief culverts removed or permanently plugged, and the road surface outsloped. Again, ditches require constant upkeep and are the cause of much road failure and environmental damage. Properly located and constructed outsloped roads usually require little maintenance, especially if traffic is minimized in the rainy season. In Figure 3-1, the outsloped road shows very little erosion even though it is a full bench section on a 70% cross slope.

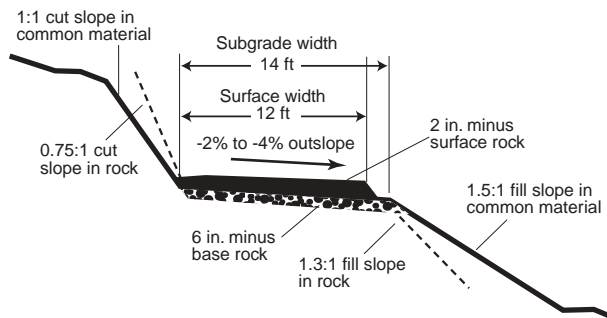

Figure 3-3. Example dimensions for an outsloped log haul road.

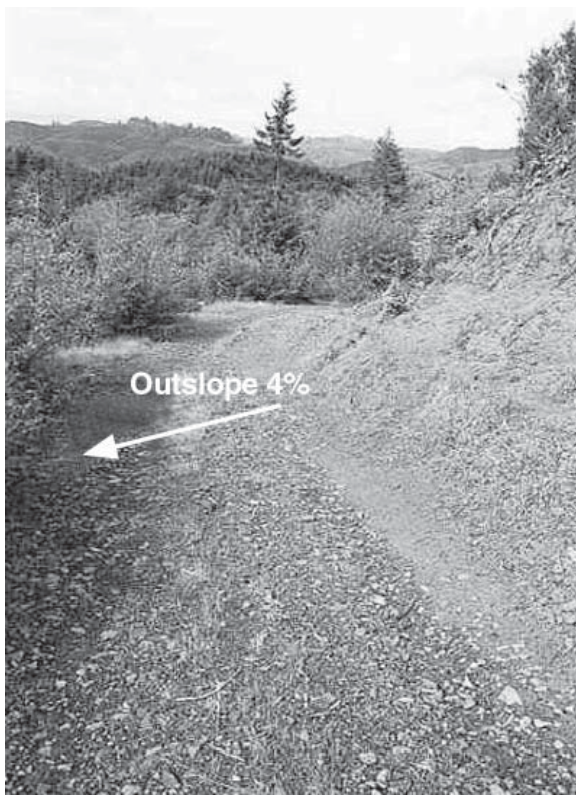

Figure 3-4. Drainage direction on an outsloped road.

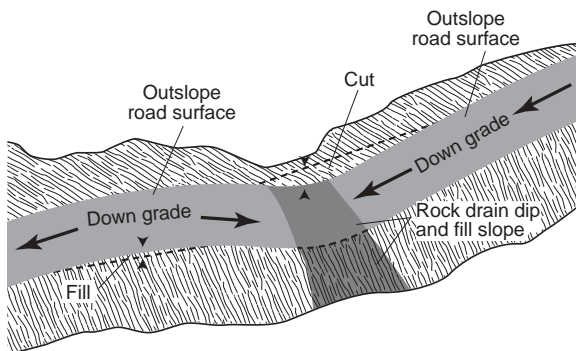

Figure 3-5. A drain dip sketch.

Similarly, Figure 3-2 shows an older outsloped road that has received very little maintenance and shows little erosion. Note that the cutbank slough (ravel) the road on the uphill side does not hinder road surface drainage. On a ditched road, this slough would block the ditch and, if not promptly removed, could result in serious erosion.

OUTSLOPED ROAD SURFACE AND DIMENSIONS

On outsloped roads, the slope of the road surface itself, along with drain dips and rubber water bars, are used to channel water away from the road surface. When subsurface water (a high water table or spring) is encountered, under-drains or short sections of ditch with relief culverts must be used to prevent the subsurface of the road from becoming saturated. Otherwise, ditches are generally not necessary. Example minimum dimensions of an outsloped road used for log haul are illustrated in Figure 3-3.

Outsloped roads should have a road surface with a negative 2%–4% cross-slope to provide for adequate drainage (Figure 3-4).

Extra care needs to be taken with road grade on outsloped roads. A vehicle traveling on an outsloped road mechanically senses the road surface outslope and road grade simultaneously. For example, a road segment with a 10% road grade and 4% outslope generates the equivalent of a 14% grade that the vehicle must operate against. Depending on the specific situation, these steeper road segments are not outsloped until timber harvest operations are concluded to keep a log truck from sliding off the road, especially in slippery conditions.

DRAIN DIPS

Drain dips on outsloped roads channel water running in surface ruts off the road surface. Essentially, drain dips augment the effectiveness of an outsloped road surface in shedding water (Figures 3-5 and 3-6).

To simplify the construction of drain dips, the road grade can be “rolled” up and down during the process of locating the road (Figure 3-7). That is, the road locator can periodically drop the road downhill slightly and then bring it back uphill slightly to accommodate drain dips, or include in the roadway rolling sections of the

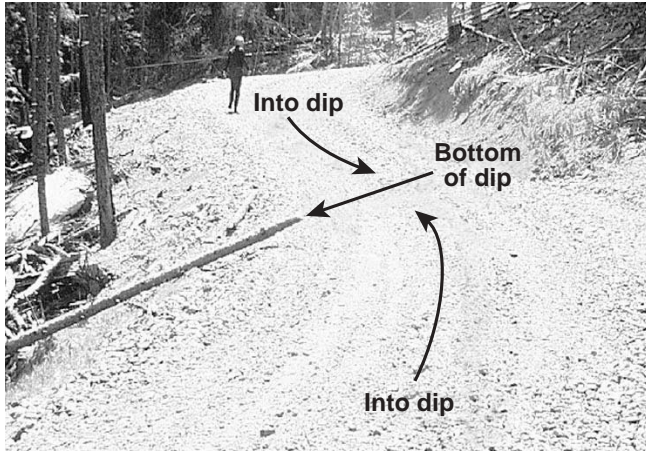

Figure 3-6. A well-constructed drain dip.

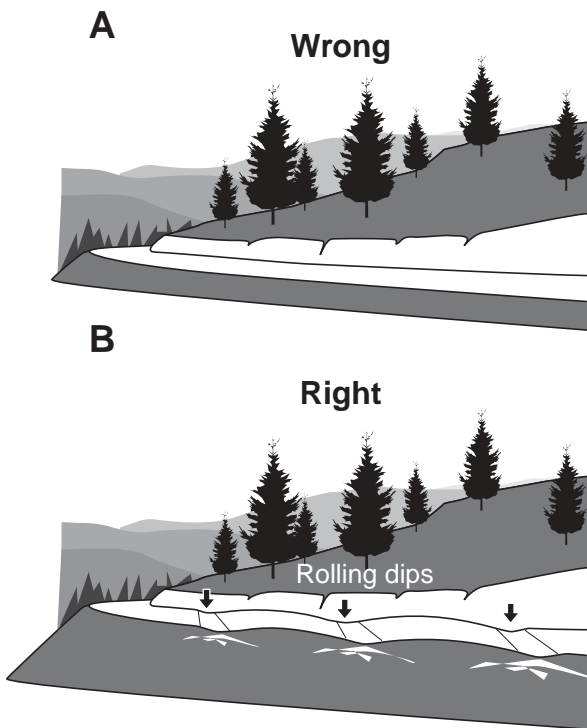

Figure 3-7. Drain dip location, wrong (A) and right (B).

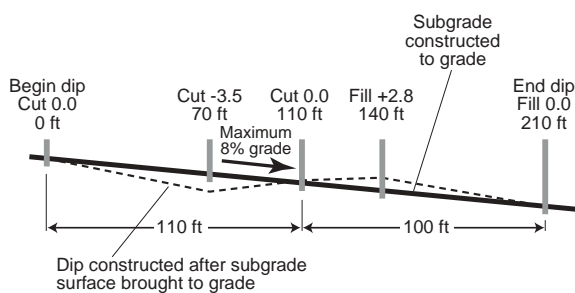
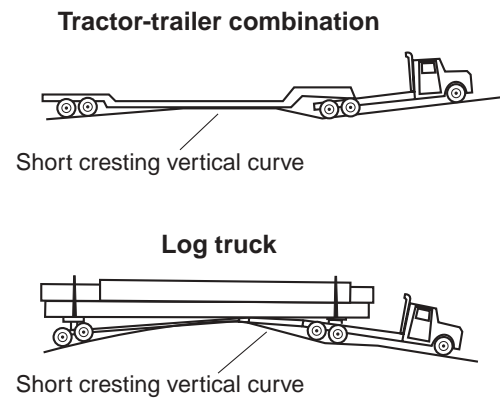

Figure 3-9. Example of drain dip construction staking.

landscape that naturally lend themselves to drain dips. On some terrain, however, it is easier to construct a dip than it is to roll the grade.

Drain dips should be carefully constructed to allow truck passage. If they are too abrupt in their total length, log trucks will broach or semi trailers will bottom out (Figure 3-8). The road grade into and out of the dip should be level and not outsloped. The level grade prevents truck frames from flexing, which can damage the truck's undercarriage and frame. When the distance between the beginning and end of the drain dip must be shorter than 210 feet, care should be taken to limit log truck and tractor-trailer passage.

If an area is harvested in the dry season, shorter drain dips are often constructed after harvest operations are completed, when only light pickup truck-type traffic will use the road for some period of time.



The design data in Figure 3-9 and Table 3-1

Figure 3-8. Improperly constructed drain dips.

below have been successfully applied to forest roads to permit passage of log trucks and tractor-trailer trucks. The drain dip standards in Table 2 can be applied on a straight section of road that is a minimum of 210 feet long. The dips shown in Table 2 can be staked out and constructed after the subgrade is already at its final elevation.

Table 3-1. Drain dip construction staking data.

Road grade (%)	Drain dip construction stake data (ft)				
	0	70	110	140	210
	Cut	Cut	Cut	Fill	Fill
2-3	0.0	-1.3	0.0	+1.0	0.0
4	0.0	-2.0	0.0	+1.4	0.0
5	0.0	-2.3	0.0	+1.8	0.0
6	0.0	-2.7	0.0	+2.0	0.0
7	0.0	-3.0	0.0	+2.3	0.0
8	0.0	-3.5	0.0	+2.8	0.0

Drain dips are constructed on road grades ranging from 2% to 8%. On grades greater than 8%, the water will run through the dip; a dip deep enough to retain the water on steeper grades will cause a log truck or tractor trailer to broach. Thus, on grades over 8%, rubber water bars can be used to divert water off the road surface (as we will see in the next section on water bars). For maximum drainage efficiency, drain dips should also be properly located on tangent (straight) road sections. Dips are generally not constructed on sections with fill slopes greater than 6 feet in height on the outside shoulder in common fill material. When the fill is constructed of common material, crushed rock can be placed on the fill slope below a drain dip to prevent erosion. A skilled road locator can plan for drain dips in appropriate locations with lower fill heights and in natural grade breaks.

The spacing of drain dips is predicated on road grade and road surface type. Table 3-2 illustrates suggested culvert and drain dip spacing based on soil type.

Table 3-2. Example road surface drainage spacing (ft).

Soil composition	Road gradient (%)		
	2-4	5-8	9-12
Granitic or sandy	400	300	200
Clay or loam	500	400	250
Shale or gravel	600	500	300

Distances used only to show importance of soil type in influencing drain spacing. In Oregon, forestry operations are required to employ distances outlined in the Forest Practice Rules as a minimum.

WATER BARS

As we saw in the previous section, drain dips are ineffective on outsloped road grades greater than 8% because water will run through them. Or, if dips are constructed steeply enough to catch runoff water on road grades greater than 8%, trucks will have difficulty getting through them without broaching or bottoming out. Thus, water bars are often constructed to control road surface runoff on steeper grades.

Like drain dips, water bars augment the effectiveness of outslope drainage. There are generally two types of water bars. The first type is constructed from subgrade material (soil or aggregate) and generally installed after logging operations. They are temporary in nature, easily broken down by traffic, and difficult to maintain effectively. They are generally built on temporary roads with no surfacing. Regular traffic may wear down this type of water bar and necessitate periodic maintenance.

The second, more durable type is a rubber water bar. On outsloped roads, rubber water bars are a highly effective method of diverting road surface runoff from the road, and



Figure 3-10. A vehicle driving over a newly installed rubber water bar.



Figure 3-11. Installing a rubber water bar

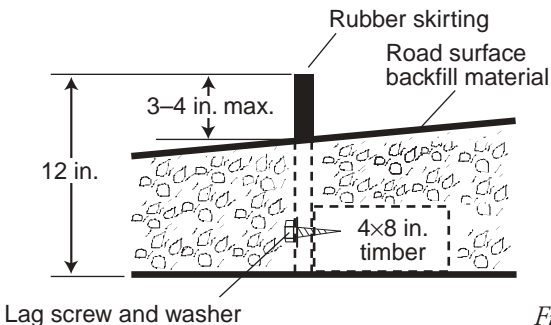
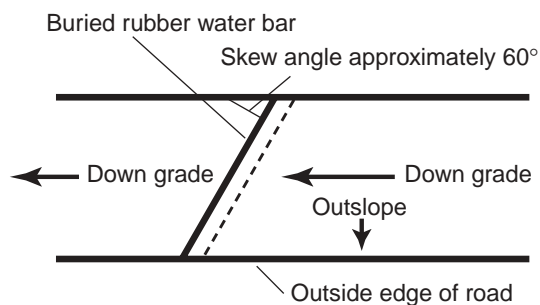

Figure 3-12. Rubber water bar installation.

are much more effective and last longer than water bars constructed of subgrade material. Rubber water bars are easy to fabricate and install, and inexpensive when compared with other drainage structures (though more expensive initially than waterbars constructed of subgrade, if the cost of maintenance is not considered). Rubber water bars can be effectively used on all road grades over 8%. In general, they are placed close enough to each other so that runoff erosion is not a problem—that is, close enough so that a large volume of water cannot gather an erosive force. For example, water bars have been successfully placed on outsloped roads at 200-foot intervals in areas with highly erosive native soil subgrades and road grades of 10% to 18%.

Figure 3-10 shows a vehicle traveling over an installed rubber water bar. When a vehicle passes over the rubber water bar the belting deflects, then springs back to its original vertical position.

A rubber water bar is easily fabricated and easily installed by a backhoe operator. Figure 3-11 shows a backhoe operator finishing a rubber water bar installation.

Rubber water bars can be constructed from a 20-foot-long treated 4 x 8 inch board and a 1-foot-wide by 20-foot-long piece of 5-ply, 12-inch-wide industrial conveyor belting. The belting is attached to the narrow face of the board with galvanized lag screws. The end view drawing in Figure 3-12 illustrates a rubber water bar installation. To install a rubber water bar, place the water bar in an excavated trench that diagonally crosses the road at a skew angle of approximately 60 degrees (Figure 3-12). The depth of the trench should permit 3–4 inches of the belting to be above the finished road surface. In common subgrade soil, rubber water bars should be installed on fill slopes with a maximum height of 5 feet at the outside road shoulder. This maximum height minimizes fill slope erosion. In subgrade material that is less susceptible to erosion, fill height could be higher.

ROAD CONSTRUCTION AND RECONSTRUCTION

INTRODUCTION

This chapter describes the construction process and construction specifications that could be used by small woodland owners for new road construction as well as for reconstruction of existing roads. This chapter provides landowners with basic knowledge of how roads are constructed, as well as basic information on soils, road grade, curves, and stream crossings. It should provide landowners with the tools necessary to more effectively oversee construction and establish contracts.

CLEARING AND GRUBBING

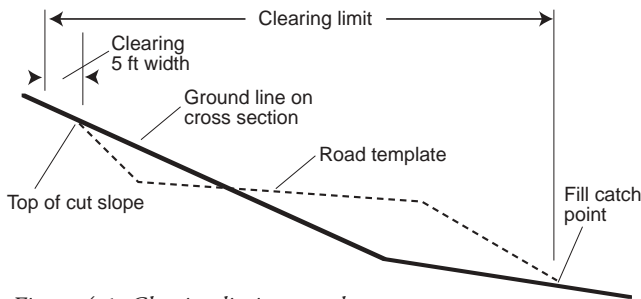

Figure 4-1. Clearing limit example.

Clearing the trees and brush from the road right of way is the first step in the road construction process. The clearing limit is the width that the trees, stumps, and organic debris are to be cleared across the future roadway. At a minimum, larger stumps that could fall on the road should be removed from the top of the cutbank, and the clearing limit should extend, at a minimum, to the toe of fills. The clearing limit itself will vary, depending on ground slope and the amount of cut and fill required. Example clearing limits are illustrated in Figure 4-1.



Figure 4-2. Tractor clearing and grubbing.

In most cases, the least costly method to dispose of stumps, unmerchantable timber, and slash is to scatter it outside and along the downhill side of the clearing limits. Unmerchantable material and stumps should be scattered with care to prevent any hazard during the logging operation and during seedling planting after harvesting is concluded. Care should also be taken to place unmerchantable material away from merchantable trees. Placing a stump, or any slash, up against a standing tree might result in high stumping of that tree during harvest, and a waste of merchantable wood.

A pioneer road allows the removal of duff, slash, brush, and merchantable timber prior to major roadway excavation. This preliminary access road is constructed within the clearing limits of the future roadway to provide for machine access and the removal of right-of-way timber (the felled timber inside the clearing limits) (Figure 4-2).

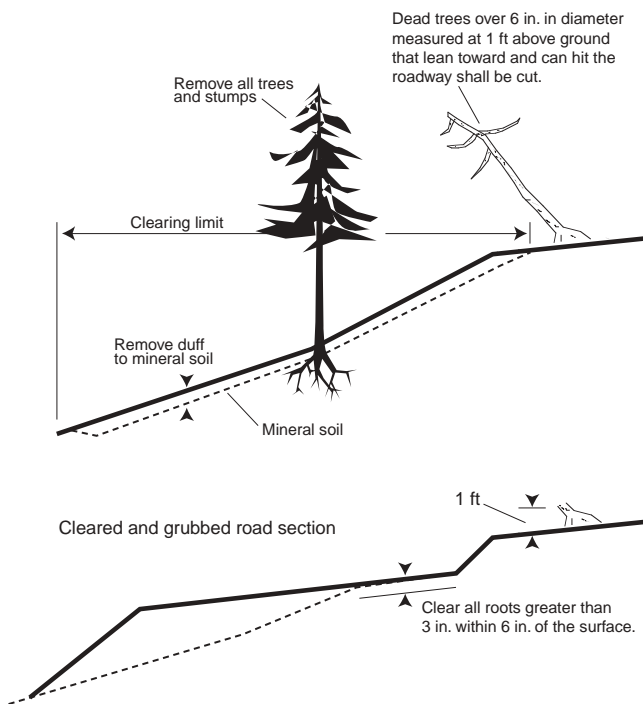

Figure 4-3. Example clearing and grubbing specifications for a section of forest road.

Controls during the construction of the pioneer road must carefully guide the digging and removal of stumps and roots within the clearing limits of the roadway. Chapter 7 provides advice on setting grubbing specifications in the road contract. Example clearing and grubbing specifications are given in Figure 4-3. These specifications will ensure that the fill material is free of large organic debris, and that hazardous trees that fall onto the roadway are removed during the construction of the pioneer road. Organic debris does not compact well; it tends to settle, causing slumps in fill subgrades.

Slash and brush within the clearing limit must be cleared and disposed of. One or a combination of methods can accomplish this task, including scattering of the slash, or burning it in piles. In general, however, the least costly method is to windrow, or scatter, slash outside the clearing limits on the downhill side of the roadway.

SOILS

Soil is the foundation of any road, though different types of soils exhibit a range of performance characteristics as a road foundation material. Some soils have strength under wheel loads and drain well, while others provide little strength and do not drain. These soils can swell and shrink during wet and dry periods until they finally break apart. Therefore, it is worthwhile to understand the basic properties of soils, how soils are identified, and how soils affect the strength and durability of a road as related to traffic, erosion, slumps, and landslides.

Unlike other uniform construction materials such as concrete and steel, soil is usually non-uniform. Soil is a mixture of natural materials combined through weathering and chemical reactions. Soil consists of solid particles of various types, shapes, and sizes. These solid particles enclose voids or spaces that contain water and gases. Because of the complex variability of soils, tests have been devised to categorize and identify soils of similar types and thus predict their engineering properties.

Several methods are used to identify and classify different soil types. The following methods are presented in simplified form so that the landowner can perform the necessary procedures without using expensive laboratory tests. For example, soils are commonly divided into four particle size categories, from largest to smallest:

- gravel
- sand
- silt
- clay
- organic matter

Gravel is rock that is greater than 0.9 inches in diameter. The larger particles are called cobbles or stones, and pieces larger than 10 inches in diameter are called boulders. Sand has a finer grain size, between 0.9 and 0.003 inches. Silt is floury sand that is still granular, but with a particle size between 0.003 and 0.002 inches. Clay, the finest soil material, has a particle size below 0.002 inches and is not considered a granular material.

Gravel, sand, silt, and clay have basic properties that affect their suitability as road building materials. In general, soils with a high percentage of silt and clay make poor roads. However, as we will see, certain combinations of soil types, including silt and clay in lower proportions, can provide a suitable road subsurface. The following is a condensed version of the soil descriptions found in the Ingersoll Rand Compaction Handbook 2000¹, an industry guidebook that presents a clear overview of soil types and how they affect road compaction and durability.

Gravel. Gravel and rock can make a strong, all-weather road, which, if properly constructed, is less subject to the erosion and wear of other types of native-soil-surfaced roads.

Sand. Whether coarse or fine, sand feels grainy and its strength is not affected by wetting. In general, pure sand such as on an ocean beach would make a poor permanent road surface because it has little cohesive strength (the grains have no attraction to one another and can be easily washed out in a rain). However, sand can support substantial weight, its strength is unaffected by wetting, and it drains well. Sand can become quite compact when its grains are vibrated or otherwise settle into their most dense arrangement. This gives sand, and other granular material, internal friction from a “stacking” action of the particles. Sandy soil mixed with silt or clay can make a good road structure by combining the positive (and lessening the negative) qualities of each.

Silt. When dry, silt is a very fine material, floury in appearance. If pure, silt will settle out of muddy water and leave it clear. It is also permeable to water, as are many granular materials. Soil with a high percentage of silt is not a good road fill material because it compacts poorly. Like sand, silt has little or no strength because its grains are not cohesive (they do not lock together). Furthermore, silt is easily pulverized when dry. If the soil in the road has a high percentage of silt it will have to be excavated and replaced, or the road relocated.

Clay. This finest soil material consists of microscopic scale-like particles, which give clay its plastic properties (its stickiness and ability to be rolled into a small ribbon when moist, as we will see in the soil test described below). Clay has several positive characteristics. For example, clay is a very cohesive material because its particles have a high attraction to each other. Clay has a high dry strength and good workability,

¹ Available online at www.ingersollrand.com, or write the company at Road Machinery Division, 312 Ingersoll Drive, Shippensburg, PA 17257

compacts readily, and has low permeability because water has difficulty flowing through the tight particle pattern. Clay also tends to withstand erosion under the force of running water. However, it has no internal friction and is therefore subject to slides, where whole sections of road slough off. Clay also shrinks and swells, which tends to break apart road surfaces. Its low permeability means that it will not drain well. Often, pockets of soil found in the roadbed with a high percentage of clay must be removed. However, road builders with substantial soil experience will sometimes mix clay with other materials (such as sandy soil or gravel) to make a suitable foundation for the road.

Organic matter. Organic matter is partly decomposed vegetable or animal matter. In soils, it appears as fibrous black or dark brown organic silts, peat, or organic clays, all of which are generally soft and have a strong odor when heated. Organic matter should not be considered for road fill material because it will continue to decompose and lose its shape, and it would provide little strength to a road's subgrade.

Despite these four distinct classifications (five including organic matter), soils in a natural state are usually found in some combination of gravel, sand, silt, and clay. For example, one might find soil that is a sand-silt mixture where sand predominates, or a silt-sand mixture where silt predominates. These combinations can lend stability to a road's fill material.

Taking into consideration soil particle combinations, the American Association of State Highway Transportation Officials (AASHTO) classifies soils into groups as related to road subgrade strength and performance (Table 4-1).

Table 4-1. Classification of soils and soil-aggregate mixtures. ¹

General classification	Stone fragments, gravel, and sand	Silty or clayey gravel, and sand	Silty soils	Clayey soils
General rating as subgrade material	Excellent to good	Excellent to good	Fair to poor	Poor

¹ From *Soils manual for design of asphalt pavement structures*, Manual Series No. 10 (MS-10), February 1969. The Asphalt Institute, College Park, MD.

When locating a road, one should check soil quality. If it is necessary to build on less desirable soils, such as pure clay pockets, it is often necessary to excavate the clay and replace it with a more desirable soil, such as silt-sand or gravel.

Landowners can perform a simple field test to determine what basic soils they have in the areas where they want to build a road. Prior to construction, representative samples should be taken at the depth road cuts will be made. For road reconstruction, soil samples can be taken from the subgrade, or from cut and fill slopes. The diagram in Figure 4-4 describes the simple hand texturing method used to determine one of the four following common soil classifications for a soil sample:

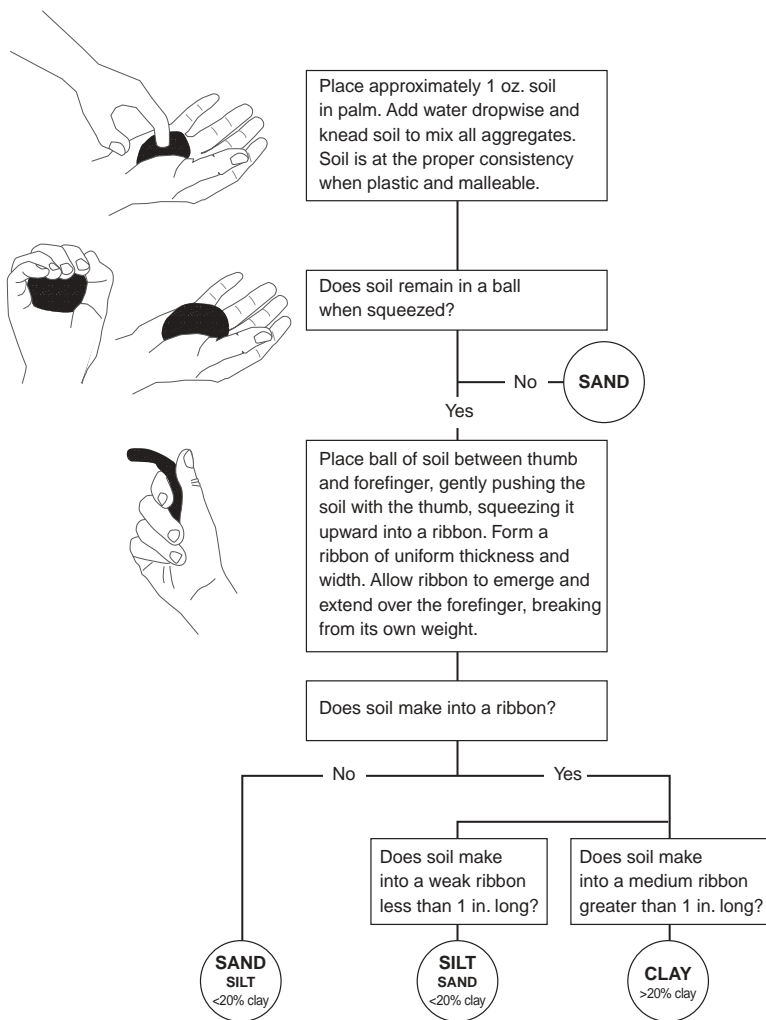

Figure 4-4. Identifying soil types with a hand procedure.

• Stone fragment and sand (larger rock and gravel particles, of course, are easily identifiable, and are not part of this hand-texturing test)

- Sand silt
- Silt sand
- Clay

In this soil test, water is added a drop at a time until the ball of soil breaks or a ribbon is formed.

You will notice that the soil test in Figure 4-4 distinguishes between soil types by their cohesiveness (their ability to stick together). Another way to distinguish between soil types is by dividing them into two main groups, cohesive and non-cohesive soils. This cohesiveness is sometimes called the “plastic” quality of the soil, or its ability to stick together and be rolled into a ribbon. Examples of cohesive materials include clay, coarse clay sediment, loamy sand, and sandy clay. Non-cohesive materials include sand, gravel, and sand mixtures. Again, however, cohesive materials (like clay or silt in high percentages) do not necessarily make a suitable road surface if they do not drain well, or if they swell and shrink. This is another reason that sandy soil mixed with silt and clay in proper proportions can help provide a road surface that is both cohesive and durable. In general, soils containing small amounts of clay and silt provide adequate road subgrade material, whereas soils containing a high percentage of clay or silt make poor road construction material.

SOIL MOISTURE

In addition to the type, size, and shape of the soil particle, the amount of moisture in any soil type determines whether it can be properly compacted. Moisture can be present in soil in three different forms:

- Gravitation moisture, or water that is free to move downward and drain from the soil.
- Capillary water, held in the capillaries or pores between soil particles.
- Hygroscopic water, or moisture that remains after capillary and gravitation waters are removed. This moisture is in the form of a thin film held by soil grains.

Hydroscopic water creates a chemical affinity between neighboring soil particles, providing a tight bond between them. Hydroscopic water will be in balance with the humidity of the surrounding air; the lower the humidity, the lower the hydroscopic water volume.

For the purposes of compaction, each of the infinite soil variations has its own optimum moisture (capillary and hydroscopic) at maximum compaction. This optimum can be determined in a laboratory by testing soil samples for their compactability at different moisture contents (a common soil compaction test goes by the acronym AASHTO T-99). Moisture content, in turn, is determined by dividing the weight of the water in a soil sample by the weight of the dry soil, expressed as a percent. This is found by weighing the soil wet, then drying and weighing it again, where the difference between the first and the second weighing represents the weight of the water.

Without conducting an expensive laboratory test, the landowner and road contractor can get a general idea of the moisture content in the soil by a simple field test:

Pack a soil sample by hand into the shape and size of a golf ball. Place the ball between the index finger and thumb. If, when squeezed, the material shatters into fairly uniform fragments, the soil is [probably] close to optimum moisture. If the material weeps [moisture comes out of the soil or the rolled soil leaves a moisture film] in your hand or does not break but flattens out, the soil is [probably] over optimum moisture. When the soil cannot be formed into a ball or is difficult to shape, it is probably under optimum moisture and moisture must be added (Ingersoll Rand 2000¹).

OTHER SOIL CHARACTERISTICS

Finally, soil has certain other properties that make it either suitable or unsuitable for road construction (Ingersoll Rand 2000). For example, shear resistance, a positive quality, comes from cohesion, when soil particles resist pulling away from each other, or from the friction between particles, such as with granular and rocky soils. Elasticity, a negative characteristic for road building, is a soil's ability to return to its original shape after a load is removed. Elastic soils like clay make poor roads because the rebounding and flexing eventually cause the road surface to break apart. Similarly, soils that shrink and swell excessively are undesirable for road construction. Generally, swelling and shrinkage occur in finer grain materials like clay (sand and gravel shrink only slightly) when water is added or lost by evaporation. In time, this swelling and shrinkage can break up a road surface. In contrast, a soil's permeability, such as when sand is a component of the soil mixture, helps the road material drain off moisture without excess growth and shrinkage. Compressibility, or the ability of the material to take on less volume under a load, can be

¹ Available online at www.ingersollrand.com, or write the company at Road Machinery Division, 312 Ingersoll Drive, Shippensburg, PA 17257

desirable if the soil does not shrink and grow excessively, if it is not also elastic, and if it drains well. Soil types with a small percentage of clay or silt often provide a good mix of these positive characteristics while avoiding less desirable characteristics such as elasticity and shrinkage.

A reputable road contractor will take these characteristics into consideration when building a road with a given soil. Again, sometimes a road can be effectively and inexpensively routed around sections that contain undesirable soils. However, where it is impossible to avoid poor quality soils, such as pockets of soil with a high percentage of clay or silt, the road contractor may need to excavate and replace the road material, or mix it with other suitable materials. Both methods can be costly. An alternative is to use a fabric blanket to reinforce the subgrade and provide separation between the subgrade particles and surface or base aggregate.

EARTHWORK

Earthwork is the volume of soil or material moved in constructing a road. Earthwork is often measured by the “bank yard,” which is defined as one cubic yard, or 27 cubic feet, of natural undisturbed soil or rock. Before it is excavated, a bank yard will have already

been compacted to some extent by nature. After a bank yard is excavated, it swells (fluffs up). Then, when the swelled material is moved and placed, the material is usually compacted to some degree by mechanical means. Generally, road subgrade soil is compacted more than it was in its natural state. However, excavated rock, unlike soil, does not usually shrink but swells when placed in a fill, even when it is compacted. Figure 4-5 shows the general relationship between the different physical states of common material and rock.

Common material that shrinks when compacted in a fill:

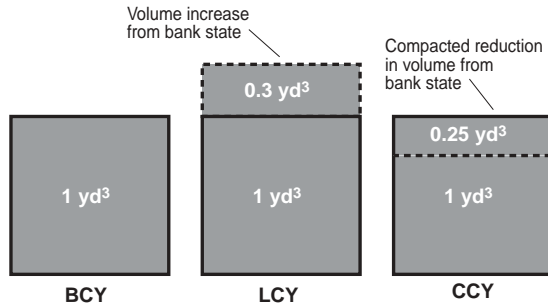

Rocky material that remains swelled when compacted in a fill:

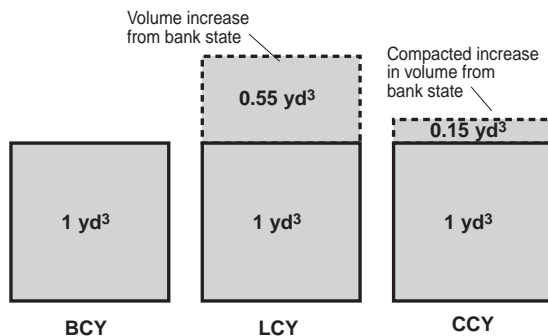

- BCY** Bank Cubic Yard (material in natural state)
- LCY** Loose Cubic Yard (excavated material)
- CCY** Compacted Cubic Yard (compacted fill material)

Figure 4-5. Physical state of excavated soil and rock.

On site, the roadway is usually constructed with a tractor (Figure 4-6) or a hydraulic excavator (Figure 4-7). Dump trucks haul material that needs to be moved farther than is economical for a tractor or hydraulic excavator.

The ripper teeth set on the back of a large tractor break up, or rip, rock that is too hard to be dug up by the tractor blade (Figure 4-8).

SUBGRADE CONSTRUCTION

The subgrade should be constructed of well-drained, compacted material. Figure 4-9 illustrates a well-drained road section constructed of well-compacted material.



Figure 4-6. Tractor constructing road subgrade.



Figure 4-7. Hydraulic excavator excavating roadway material.



Figure 4-8. Tractor with a hydraulic ripper attachment.



Figure 4-9. Road constructed with well-compacted and -drained subgrade.

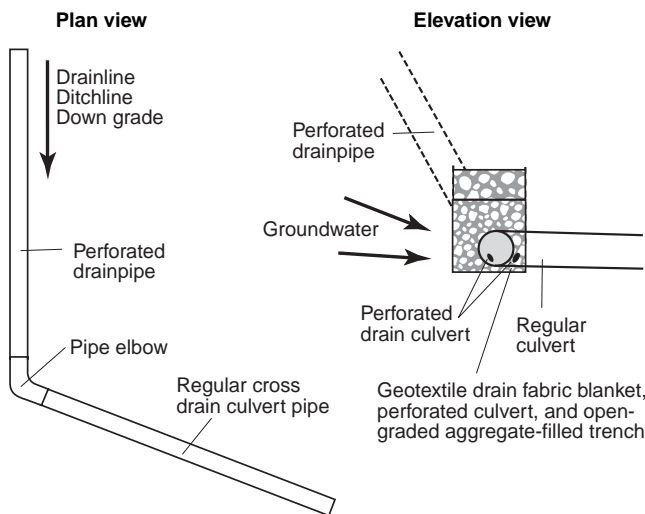

Figure 4-10. Under-drain used to cut off groundwater before it seeps into the subgrade.

Unsuitable material such as wet clay pockets, or subsurface water that enters the subgrade, can cause serious and continual maintenance problems. Groundwater (underground water or channels) in the cutbank or under the subgrade must be cut off with a ditch to keep it from entering the subgrade. Spring water or any groundwater running under the subgrade can be cut off with an under-drain that is constructed with a trench at an elevation lower than the flowing ground water, as shown in Figure 4-10. A perforated drainpipe or filter aggregate wrapped in a geotextile filter cloth is used to trap the water and carry it across and away from the road.

Road fill material that is soil or soil mixed with rock should be placed in approximately 1-foot layers and compacted before adding the next layer. The amount of compaction achieved will de-

pend on the moisture content of the soil and the energy expended on compacting. The more the soil is compacted, the tighter the bonding of the soil particles and the smaller the air voids.

For ideal soil compaction, the soil is mechanically compacted at optimum moisture to within 90%–95% of its maximum density. This level of compaction often requires a mechanical roller, along with soil sampling and laboratory testing to determine optimum compaction, though the optimum is generally beyond the scope of small woodland operations. Various types of compaction equipment are used; for example, smooth wheel vibratory rollers and sheep-foot rollers. The drum in a sheep-foot roller has metal projections, or “feet,” that sink into uncompacted soil. When the projections no longer sink into the surface, the road is considered to be well compacted.



Figure 4-11. Splitting wheel or cat tracks when spreading and placing fill material to obtain additional compaction.

At a minimum, small woodland operations can require that the grade tractor and dump trucks, if used, help compact the fill by splitting tracks and tires (that is, driving between previous tracks) while operating back and forth on a fill (Figure 4-11). Under the proper conditions, this method will gain up to approximately 80% of optimal compaction. While not ideal, any compaction is better than no compaction.

Rocky material larger than 1 foot in diameter should be buried in the fill at least 2 feet below the surface of the subgrade. Unsuitable material such as clay and organic matter is often excavated and moved to a suitable waste site. This material is replaced with suitable fill material.

GEOTEXTILES

Geotextiles, which are made of a synthetic fabric, are sometimes an effective option in very wet soils or other soils that do not compact well, such as certain loams. The geotextile material is added on top of the subgrade or incorporated in the subgrade to provide additional strength to the subgrade and thus reduce the depth of surface rock. The fabric should be installed following the manufacturer’s recommendations, and carefully, to avoid tearing the material. There is a cost trade-off between reducing rock depth and installing geotextile fabric. On wet ground, geotextiles can help keep moisture from surfacing or keep soil and road surface aggregate layers from mixing. The landowner, with the help of a forest road engineer, should determine the trade-off of cost and effectiveness between buying and laying down the geotextile versus excavating and replacing the road material or reducing the depth of surface rock.

ROAD SURFACING AND A LOGGER'S OPERATING SEASON



Figure 4-12. Native-soil-surfaced road.

Essentially, the two “seasons” for logging operations in western Oregon and Washington are dry summers and falls, and wet winters and springs. During the dry season, less road surfacing is generally needed, whereas winter logging requires all-weather roads and higher standards, such as rock aggregate surfaces.

The two most common types of road surfacing are native-soil and aggregate (crushed rock) road surfaces. Aggregate surfacing provides more strength to the road surface for vehicle passage than do native-soil road surfaces. In inclement weather, rock surfacing extends the life of the subgrade by helping to keep it from becoming rapidly saturated and significantly rutted. Figures 4-12 and 4-13 illustrate native-soil and rock-surfaced roads.

NATIVE-SOIL SURFACING

Again, native-soil surfacing can be used when harvest operations are conducted during dry weather. This type of road surface is generally more susceptible to erosion than are aggregate-surfaced roads. Traffic control must be maintained during wet weather to avoid serious road surface ruts and subsequent erosion and runoff damage. Well-drained and compacted soil helps avoid road damage.



Figure 4-13. Rock-surfaced road.

ROCK SURFACING

Aggregate is rock that is either excavated with a tractor or blasted into pieces small enough to be crushed with a mechanical rock crusher to the appropriate mix of particle sizes. If, for example, a road contract specifies a 6-inch minus base aggregate, the contractor must apply a specified range of sizes of crushed aggregate 6 inches and smaller. Rock aggregate surfacing is placed on a road subgrade to add strength to support vehicle traffic, provide wheel traction, provide a relatively smooth traveling surface, and reduce road surface erosion. When compacted, the rock particles bind together for added strength.

Because the subgrade material found on site can vary in strength, the need for an aggregate surface can also vary. A rock subgrade may require no surfacing, while a weaker common-soil subgrade could require a base and surface layer of aggregate for an all-weather haul.

For effective log hauling, all-weather rock-surfaced roads in the western Pacific Northwest can be constructed with varying sizes and depths of aggregate surfacing. Depending

on the strength of the subgrade, a single layer or multiple layers of surfacing are used. A surfacing system using two different lifts (layers) of rock surfacing can provide added strength to support vehicle wheels, enhance wheel traction, provide for log haul operations during inclement weather, and reduce road surface erosion and subsequent road maintenance. There are two main procedures used in rock surfacing roads. The first is to use several lifts of rock of the same gradation. The second is to use a larger base rock and place a surface aggregate over the base. The advantage of the base rock is that it is generally less expensive than several lifts of smaller aggregate. The advantage of having the surfacing of the same size aggregate is ease of surface maintenance. When roads with base rock surfacing have rutting, the base rock can mix with the surface rock, causing extreme difficulty in reblading the surface with a motor grader.

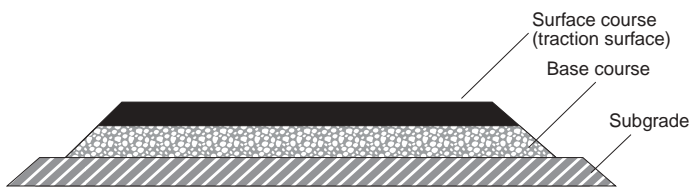

Figure 4-14. Rock road surfacing, base, and subgrade.

On roads where base rock is used on the first lift, it is placed on the subgrade to provide added strength to support vehicle wheels and help retard moisture penetration into the subgrade. A traction surface lift is then placed on top of the base rock to provide for better traction and smoother running surface (Figure 4-14). On grades over 16%, a traction layer, 1-inch- to $3/4$ -inch-minus dense grade rock, is placed on the top of the 6-inch-minus base rock to provide for enhanced vehicle wheel traction.

Sometimes on short all-weather spur roads with grades less than 10%, only 6-inch-minus base rock is used.

The aggregate's shape, durability, and wearability will also affect the quality of road surfacing:

Shape. The aggregate should be angular but not sharp enough to puncture vehicle tires. Angular aggregate particles are locked together when compacted, adding strength to the road surfacing. River gravel, as opposed to mechanically crushed gravel, is often too rounded to compact adequately.

Durability. The aggregate should be durable enough to resist fracturing under repeated tire loads. Aggregate that fractures under a load will break down and reduce the strength of the surfacing.

Wearability. The edges of aggregate particles should not easily wear or round off when driven on; this would reduce the bonding action of angular particles and thus reduce road surface strength.

Hardness. The rock must be hard enough to withstand vehicle tire pressure without fracturing.

There are two general types of aggregate road surfacing used on forest roads. The first, and often least expensive, type of rock surfacing is called pit run rock, which is rock out

of a pit that is not processed by a mechanical crusher but broken up by a tractor's rippers or by blasting. This rock often fractures easily and can be excavated with a bulldozer and then hauled, dumped, and spread on a road's subgrade. Oversize rocks are bladed off the roadway while the rock is being dumped and spread.

Pit run rock with a size range of 6-inch to 3-inch-minus is used for both the base and for surfacing on grades below 10% where vehicle truck tire traction is not a problem and vehicle speed is not a consideration. The rock is dumped on the subgrade and spread over the width of the running surface and beaten into the subgrade with a tractor or tractor and grid roller.

The second and often more expensive type of rock surfacing is crushed aggregate, which is angular rock that has been mechanically crushed to specific particle sizes to provide a mixture of different sizes or gradations. This aggregate can be compacted into a dense lift, adding strength and reducing moisture penetration into the subgrade. It provides a good running surface when properly applied, and in general can provide more traction on steeper grades than is possible with pit run rock. Aggregate is generally the strongest, most common all-weather surface on unpaved forest roads.

Again, different grades of aggregate can be used. Base rock can be 6-inch-minus, and surface rock can vary from 3-inch to $\frac{3}{4}$ -inch-minus. The strength and durability of the aggregate also depends on the specific mix of sizes of rock particles. After it is crushed, aggregate rock is passed through sieves that allow a fixed percentage of different specific sizes of rock to emerge. For each grade of rock, specifications call for a certain percentages of aggregate sizes to assure that the aggregate particles will lock together when compacted, and thus the rock particles will not tend to ravel (roll off). If, for example, a road contract requires a 2-inch-minus "dense" graded surface aggregate, the contractor must apply a specified range of sizes of crushed aggregate 2 inches and smaller (the rock crushing outfit should be able to provide these specifications). If landowners are investing a significant amount of money in aggregate, they can require in the road contract that the aggregate be tested and certified to be within specifications. The road contractor would then be required to provide test results from a certified testing laboratory.

The choice of which type (pit run versus crushed rock) and grades of aggregate to use in road construction depends on several factors:

- Subgrade strength as related to vehicle wheel loads
- Road grade
- Number of vehicles using a road
- Season of road use
- Aggregate availability
- Cost

Again, aggregate that is not within the specific gradation can provide an inferior road surface because it will not bond as well and can tend to ravel easily with traffic wear.

This can occur if the rock is not crushed to specification, or if the rock particles later “segregate.” Segregation occurs when the larger and smaller particles separate from each other. Crushed aggregate can segregate when placed in stockpiles, or when the load is hauled and spread. Like aggregate that does not meet specifications, segregation destroys the gradation and results in an inferior road surface.

In addition to assuring that the fine and larger rock material is still evenly mixed when placed on the subgrade, the contract should also require a maximum thickness for any one layer. For example, to build up 6 inches of rock, 3-inch-minus rock (and smaller grades) is often added in two to three lifts (layers) to assure it is thoroughly compacted. If soil is substituted for fine crushed aggregate (or if soil ravel onto an aggregate road), the fine and coarse aggregate will not bond properly. When wet, the soil particles will lubricate the aggregate particles to make them slip and lose bonding strength.

As with soil compaction, road surface aggregate must be compacted with a certain moisture content to attain optimum compaction and the greatest performance from the surfacing. As with soil moisture, tests can determine moisture content in aggregate. However, laboratory tests are uncommon. Instead, road builders use experience and judgment to determine the moisture content of the aggregate before compacting it.



Figure 4-15. Smooth-wheel vibratory roller compacting surface rock.

The rock should be mechanically compressed to be sufficiently compacted. The trucks delivering the rock to the site can, and indeed should, begin compacting the road surface by splitting their wheel tracks while running on the newly placed rock. Landowners can require this in their road contract (Chapter 7). Optimum rock surface compaction, however, usually requires a self-propelled smooth-wheel vibratory roller, shown compacting surface rock in Figure 4-15. Optimum compaction can be cost-prohibitive for some small landowners, but it is wise to follow the maxim: some compaction is better than no compaction at all.

Rock cost, whether pit run or aggregate, is a function of the gradation requirements, quantity used, distance hauled, and the processing requirements (such as spreading, watering, shaping with a grader, and compacting with a roller). In many areas of the Pacific Northwest, surface rock can be the single most expensive element of a forest road.

ROAD GRADE

Road grade is the difference in elevation between two points along a road surface. Grade is positive (+) uphill and negative (-) downhill. Grade is expressed in percent (%), the vertical change of a road elevation for a given horizontal distance along the road. For example, the change of grade uphill (+) 10% would be a change in elevation of 10 verti-

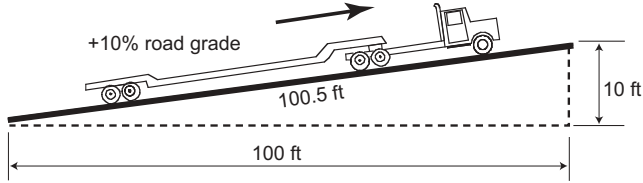

Figure 4-16. Road grade example.

cal feet in a distance of 100 horizontal feet (100.5 feet along the road) (Figure 4-16). A negative road grade in the direction of a loaded log truck is called a favorable grade. A positive grade in the direction of a loaded log truck is called an adverse grade.

The grade on any road should be a minimum of $\pm 2\%$. Grades less than that do not drain well, and small ruts can cause standing water to collect. Ditch grade is usually the same as road grade and has the same minimum; ditch grades less than minus 2% can hold

standing water, which can seep into the subgrade.

Under normal road surface conditions, the ability of a loaded log truck to negotiate adverse (uphill) grades must also be considered. Maximum adverse grade with a loaded log truck can be approximately 16%–20%. On compacted rock-surfaced roads, adverse grades up to approximately 12% are usually not a problem. At or below this grade, a log truck's tractor drive wheels will usually not spin out, and a truck will usually not become stuck on the hill as it might on steeper grades. On grades between 12% and 20%, the landowner must consider compaction and size of rock. For example, $3/4$ -inch-minus surface rock has been successfully used by some landowners to provide traction on steeper grades. On grades over 20%, an assist vehicle is generally required to help pull the loaded truck up the grade.

On native-soil-surfaced roads where the soil moisture and compaction are ideal, loaded log trucks have negotiated adverse grades up to 20%. However, ideal conditions are rarely met, so competent contractors will usually keep road grades below 20% without special surfacing.

HORIZONTAL CURVES

Horizontal curves are used to change the direction of a road left or right. Various radii curves can be used, depending on topography, vehicle speed, and vehicle type. On relatively short single-lane roads, speeds usually do not exceed 20 mph. At the lowest vehicle speeds, 50 feet is often considered the absolute minimum turning radius (about 45 feet turning radius on a fully cranked tractor-trailer steering wheel, plus a slight margin for driver error), though some people in the industry consider 60 feet and above a minimum. Vehicle "off tracking"—the way tractor wheels on a logging truck, and the tractor-trailer itself, pull to the inside on a curve—will also have to be considered in constructing a curve. (Off-tracking considerations for curves will be covered in more detail under the section on Road Surface Widths, below.) On switchback curves or in narrow draws, or around ridges where tight curves are necessary, the trick is to minimize the radius while allowing a safe and sufficient vehicle passage by accommodating vehicle off-tracking.

In planning a curve, the road engineer can trace the tangents, or straight sections of the road, and their points of intersection (PI) (Figure 4-17).

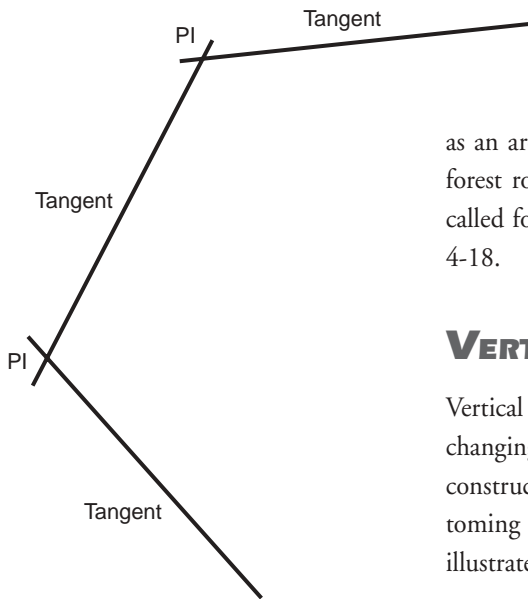

Figure 4-17. Surveyed road tangents used for horizontal alignment control.

The engineer can then adjust the horizontal curve between tangents to the desired turning radius (Figure 4-18). For most forest roads, simple “circular” curved sections are used; in other words, the curved section of road is laid out as an arc, which is a portion of a whole circle (see the dashed line on Figure 4-18). A forest road engineer can lay these out easily on the ground, or, when a road design is called for, with a road curve template. Basic curve nomenclature is illustrated in Figure 4-18.

VERTICAL CURVES

Vertical curves are used to make transitions between changes in the road grade, such as changing from an uphill to a downhill grade, and vice versa. Vertical curves must be constructed with a curve length (L) long enough to permit a truck to pass without bottoming out or broaching and also for safe sight distance. Vertical curve nomenclature is illustrated in Figure 4-19, and the types of vertical curves in Figure 4-20.

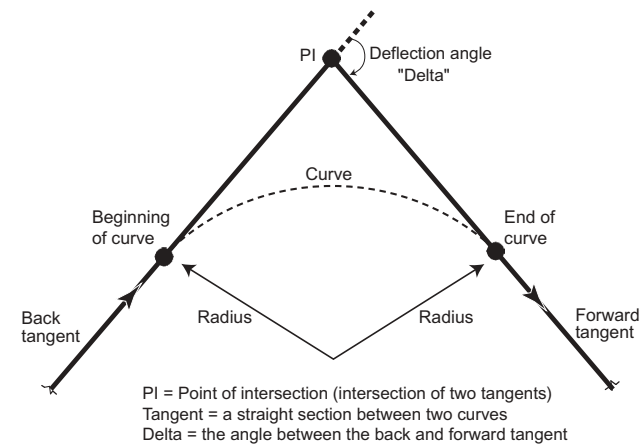

Figure 4-18. Horizontal curve description.

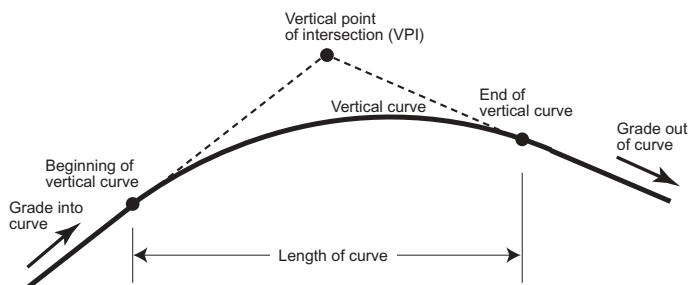

Figure 4-19. Vertical curve description.

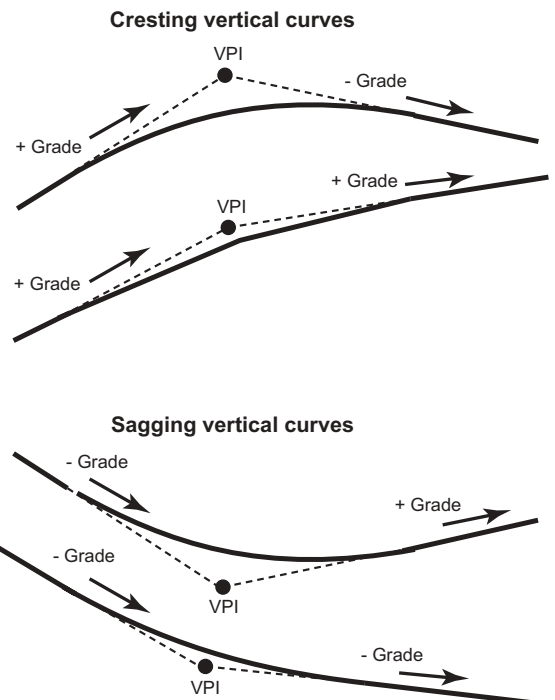

Figure 4-20. Types of vertical curves.

the curve (G2) is -4%, the algebraic difference is 10%. This is then translated into a standard length for a vertical curve. Example lengths of vertical curves are below. Note the curve lengths are conservative, depending on the type of vehicle use. On shorter vertical curves, some types of logging equipment would not be able to pass without bottoming out or broaching.

- 0%–5% algebraic difference in grade = no vertical curve necessary
- 6%–10% algebraic difference in grade = cresting curve 125 feet long; sagging curve 85 feet long
- 11%–15% algebraic difference in grade = cresting curve 185 feet long; sagging curve 125 feet long
- 16%–20% algebraic difference in grade = cresting curve 250 feet long; sagging curve 165 feet long

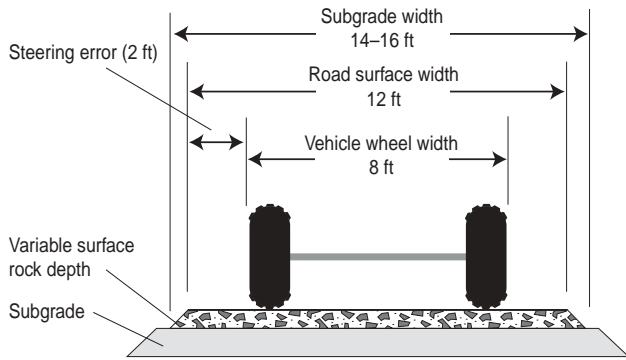

Figure 4-21. Determination of minimum finished road surface width.

ROAD SURFACE WIDTHS

Forest roads should have a minimum road surface width that is added to a log truck or tractor-trailer's standard wheel width of approximately 8 feet. Because the truck driver should have a steering safety margin of 2 feet on each side of the truck's steering wheels, the minimum road surface width is generally 12 feet (on relatively easy ground and for very slow vehicle speeds this width is sometimes narrowed to 11 feet). When surface rock is applied on the road, the shoulders of the rock surface are tapered above the subgrade surface, requiring additional subgrade width (Figure 4-21).

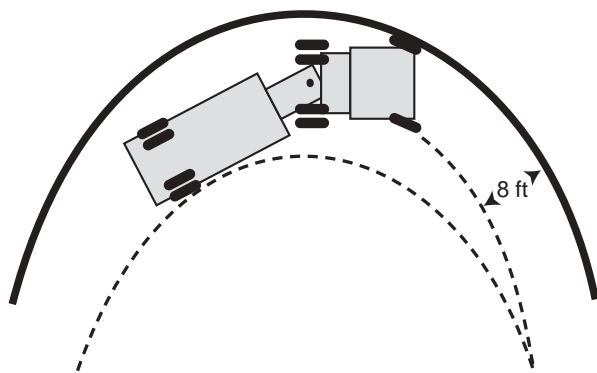
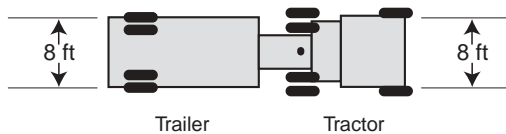

Figure 4-22. A vehicle off-tracking on a horizontal curve.

VEHICLE OFF-TRACK WIDENING

Off-tracking is the horizontal distance a vehicle's rear wheel set or sets move toward the inside of the road on a horizontal curve where the rear wheels do not exactly follow tracks of front wheels. Off-tracking is a function of curve radius, curve deflection angle, and vehicle configuration (Figure 4-22). The subgrade and surface should be widened through horizontal curves to accommodate the off-tracking of the trucks that will use the road.

As we have seen above, the minimum road width on a straight section of road is usually 12 feet, which accounts for vehicle width and a driver's steering error. However, this minimum width is insufficient on curves, where the road will have to be widened to account for off-tracking. Generally, the tighter the curve, the more widening necessary.

In general, a road engineer will minimize turning radius wherever sight distance and speed is not a concern (which is often the case for forest roads on smaller, private landholdings). However, a shorter radius means that more curve widening is necessary to provide for vehicle off-tracking.

Table 4-2 illustrates the additional off-tracking road surface width required on a 12-foot road surface through a 60-foot horizontal radius curve with deflection angles from 30 to 160 degrees. The larger the deflection angle, the sharper the curve becomes.

Table 4-2. Log truck and tractor-trailer off-tracking on a 60-foot-radius horizontal curve having varying deflection angles.

Deflection angle (degrees)	Log truck off-tracking (ft)	Tractor-trailer off-tracking (ft)
30	2	6
40	3	8
50	3	8
60	4	9
70	4	10
80	4	11
90	4	11
100	5	12
110	5	12
120	5	13
130	5	13
140	5	14
150	5	14
160	5	14

Note: Off-tracking values are rounded to the even foot.

WIDENING FOR TURNOUTS

A turnout is an added road lane width providing a second lane for a short distance. This provides for the safe passage of two vehicles in opposite directions on a single-lane road (Figure 4-23). To facilitate this, truck drivers often use CB (citizen band) radios to communicate their position. Often roads have temporary milepost signs posted during hauling operations to signal to trucks their location on the road. With this method of communication between truck drivers, turnouts can be located at convenient locations rather than providing turnouts within sight of each other. To further reduce construction costs, turnouts are often located at points that require little roadway excavation, or located where waste material must be placed.

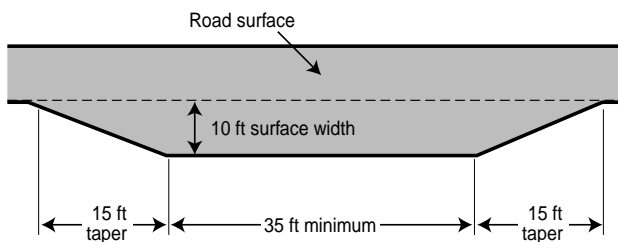

Figure 4-23. Vehicle turnout example.

Example turnout dimensions are shown in Figure 4-23.

When possible, turnouts are placed on the side of the road in the direction the empty log truck is traveling. This is done to yield the right-of-way to the loaded truck so it does not have to slow down or stop.

STREAM-CROSSING STRUCTURES

Stream-crossing structures are an important and costly element of forest roads. Because of environmental concerns in recent years, many constraints have been placed on road structures that cross streams. These requirements assure that the structures can handle flood flow capacity and provide for fish passage, while reducing sediment and turbidity yields. In the Pacific Northwest, all structures that cross perennial streams must be designed to carry the flow of a 50-year flood event (defined as a flood large enough in that particular stream to have only a 2% chance of occurring in any year).

Fish-bearing streams also require adherence to regulations pertaining to fish passage through drainage structures. Each state in the Pacific Northwest has specific regulations and procedures regarding fish passage through road drainage structures. For example, the Oregon Department of Forestry classifies streams by whether they provide fish habitat. If a road crosses a stream with an “F” designation, bridges, culverts, and drainage structures would have to allow fish passage and be built following state guidelines. The velocity of water through a culvert pipe, for example, cannot exceed the capability of fish of particular age classes to swim through it. There would also be limitations on when the stream could be entered with construction equipment. At a minimum, a 50-year flood event is the design flow criterion for forest road stream structures. To properly construct a stream-crossing structure that will withstand a 50-year flood and allow fish passage, a landowner will need the guidance of an engineer. For general advice, contact the department of forestry in your state. The road contract should also require that the contractor follow the state forest practices regulations, which sets specific guidelines for stream-crossing structures.

A professional engineer should perform drainage structure designs, especially on fish-bearing streams. State forest practices regulatory organizations have published literature to assist in proper design and installation of these structures. Requirements are constantly changing and will not be addressed in this publication; instead, landowners should contact their local forest practices forester, who can provide information on regulations and information regarding approved structures.

ROAD INTERSECTIONS

Road intersections must be constructed so that logging trucks and trucks carrying logging equipment on trailers (usually carried on “lowboy” trailers) can easily turn in the direction of the haul (Figure 4-24). Additional width for the curve will be added at the intersection to allow for vehicle off-tracking (lowboys, if they are necessary, off-track even more than logging trucks). Figure 4-24 shows a “Y” intersection. A “T” intersection could

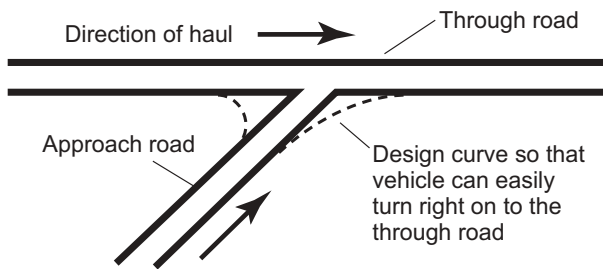

Figure 4-24. A properly designed road intersection.

also work, but when a Y is used, the approach road at the intersection should be in the direction of the haul.

There must also be a common grade at a road intersection for a distance down each road from the center of the intersection. The distance depends on the geometry of the intersecting roads. This is done to provide for a gradual transition in road grade. Tight Y intersection on a steep grade should also be avoided because the cut slope of the approach road can undermine the intersected road's fill slope, or vice versa.

To avoid this, the angle of the Y intersection should be made less severe, or the intersection should be relocated.

TIMBER HARVEST EQUIPMENT LANDINGS

Timber harvest log landings are designed and built to provide sufficient room for harvested logs as well as the safe operation of logging equipment. On difficult terrain, landings should be carefully planned and located at the same time the road is located to assure that logging operations are as efficient as possible. Landings are generally established in a harvest plan.

EROSION CONTROL



Figure 4-25. Excellent planted grass erosion control on a road cut bank.

Erosion control is important for two reasons: to protect the road and to minimize or eliminate sediment transport into streams. On an adequately constructed and maintained road, the majority of erosion generally occurs during the first 2 years of life after a road is constructed because fresh cut-and-fill slopes are susceptible to accelerated erosion; small loose material ravel from cut banks and out of freshly cut ditches.

At a minimum, landowners can easily revegetate cut-and-fill slopes by hand with a seed spreader. County agriculture or forestry Extension agents can provide landowners with information on appropriate seed mixes and when and how to plant them. A well-established grass cover is illustrated in Figure 4-25.

ROAD LOCATION

Road location is the “foundation” of any road. A road constructed in a poor location can fail and cause serious environmental damage, as well as add financial strain from continuous and costly maintenance problems. Even if it does not fail, a poorly located road might not meet a landowner’s objectives, whether for harvesting timber or providing for future road access. Not enough emphasis can be placed on properly and carefully locating a road.

Landowners should know how roads are located for construction. The type of construction controls used to establish road location should be clearly stated in the logging contract (see Chapter 7). To assure their management objectives will be achieved, landowners should also review road locations on the ground with the contractor prior to construction. This review can be required in the contract.

At the outset of the project, road design elements and standards must also be determined for the type of road to be located and constructed. Road design elements include road grade, grade breaks, horizontal curves, turnout location, surfacing road intersections, stream crossings, and harvest landings. Road standards for these elements would include subgrade width, minimum horizontal curve radius, cut and fill slope ratios, minimum and maximum grades, and so on. These, too, should be clearly defined in the road contract to assure the landowner’s management objectives are met.

Below are described two common methods used to establish road construction control on the ground. The first is the “direct location” method, where the road is located on the ground without mapping the site and without office calculations. This procedure is often used on relatively easy ground that requires few roadway cuts and fills. The second is a survey and design procedure used on a road location that requires field surveys and an office design. Survey and design are used on difficult ground requiring relatively large quantities of material for roadway cuts and fills. A common procedure used is the field survey’s “P-line” (the preliminary surveyed line determined on site) and “L-line” (the location of the road determined during office design). In setting the L-line, the road engineer considers the on-the-ground characteristics such as cross-slope, horizontal alignment, and grade to adjust the “P-line” in order to minimize the movement of earth and environmental hazards.

A road location must be accomplished on the ground, regardless of the procedures used for road construction control (whether direct location or survey), to assure a road can be

properly constructed to meet management and environmental objectives. In either method, the goal is to get a road from one point to another in the most efficient manner, with the least amount of earth movement and the least amount of follow-up maintenance and environmental damage, given slope, topography, and ground stability, as well as the operating constraints of the vehicle, such as turning radius and grade.

In applying the direct location method, most road design work is accomplished in the field during the location process. This less costly method requires a knowledgeable person who has considerable experience in road location, design, and construction practices. In general, the road locator works to efficiently get the road from point A to point B, while dealing effectively with difficult sections and environmental hazards, such as stream crossings, wet slumpy ground, sharp ridges, overly sharp turns, headwalls, and draws. The locator also plans for road intersections and log landings.

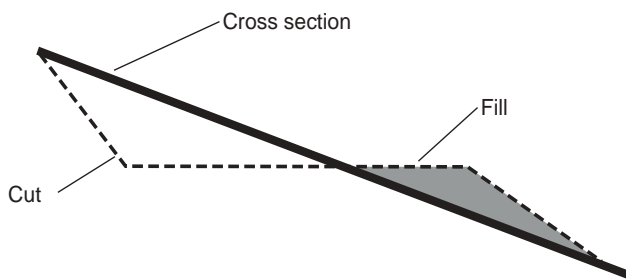

Figure 5-1. Balanced earthwork section example.

The direct location method is best suited for ground where “balanced” road sections can be located. A balanced section is a distance along the road location where the cut (the excavated material from the uphill side of the road) equals the fill (the compacted material on the downhill side of the road) within short distances (up to about 150 feet) along the roadway. This will occur on ground with cross-section slopes of approximately 35%–45%. An example of a balanced section is in Figure 5-1.

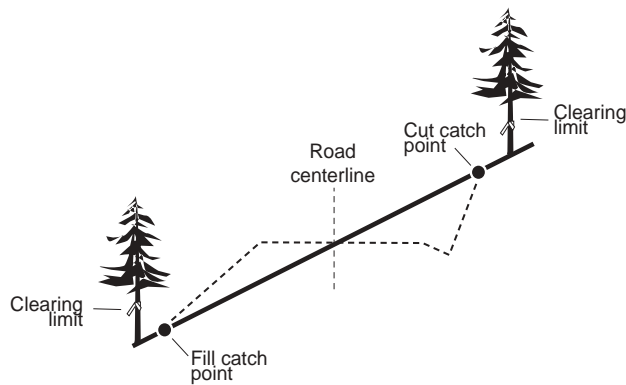

Figure 5-2. Construction survey staking a road section.

Once a direct location has been established, the catch points are established and the clearing limits flagged (Figure 5-2). In some cases, the clearing limits are also the catch points, and thus only the clearing limits are flagged. When this has been accomplished, road construction can commence.

Clearing limits can vary on the cut and fill slopes, depending on the depth of the cut and fill. It is desirable to clear at least 5 feet beyond the catch point of high-cuts with large timber to assure that stumps and live trees will not cave off the cut bank and onto the road. On the downhill fill side, clearing limits can vary. Minimum effective downhill clearing is generally to the toe of the fill.

PRELIMINARY AND LOCATION SURVEYS, AND DESIGN (THE P-LINE, L-LINE OFFSET METHOD)

The direct location method is not effective when a road location must be made on difficult terrain where large amounts of road excavation material must be moved more than a few hundred feet in order to balance the earthwork. On more complex terrain, balanc-

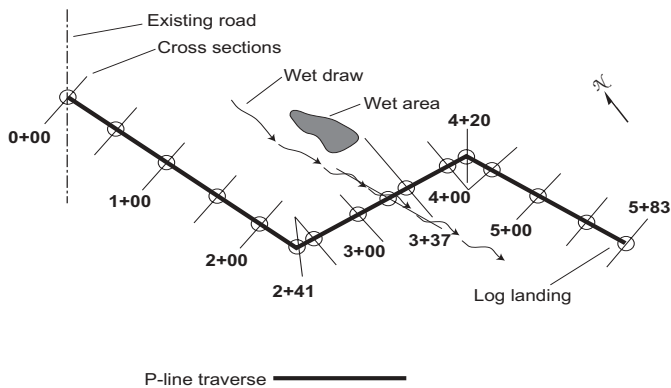

Figure 5-3. Plot of a preliminary P-line traverse survey.

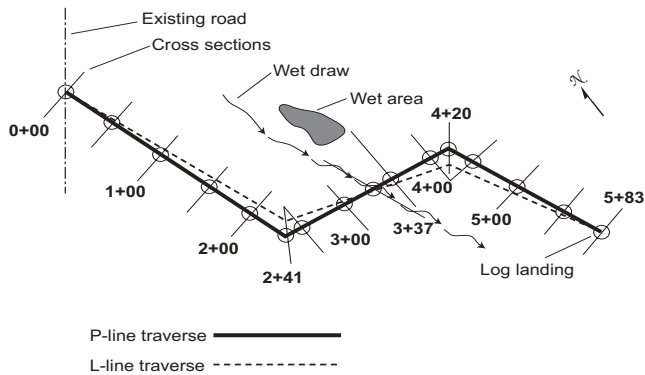

Figure 5-4. Plot of a location L-line design.

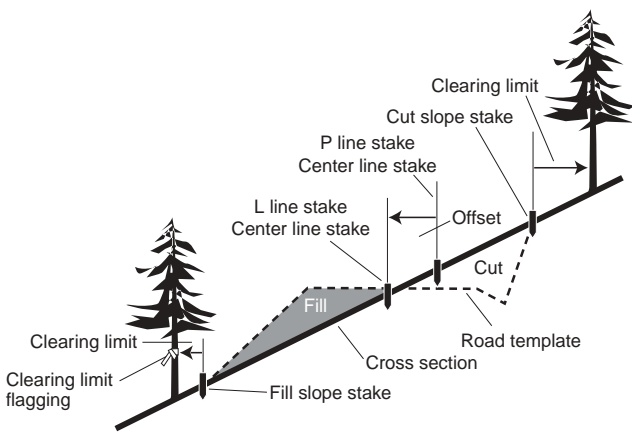

Figure 5-5. Example L-line design road section, construction-staked.

ing earthwork involves calculating the excess or deficit material needed to make cuts and fill and distributing this material at the most economical points along a road to be constructed. In order to accomplish this, the road location is first surveyed to gather the data necessary to perform the office design calculations that will be used to guide construction (Figure 5-3).

Note that the numbers in Figure 5-3 correspond to the horizontal distance in hundreds of feet from the intersection with the existing road. Thus, 3 + 37 (along the wet draw pictured) indicates that the new road crosses the wet draw 337 feet from the intersection (at 0 + 00) with the existing road.

After an initial on-site survey to set the preliminary centerline of the road (P-line) and during the office design, a location design centerline (L-line) is established for construction control and to minimize earthwork. This L-line can be offset from the preliminary survey's P-line (Figure 5-4) and will be used later to set road construction control on the ground.

In Figure 5-4, the cross-mark through the circles represents each station or distance between stations along the survey line and shows how far the cross-sections have been surveyed on each side of the P-line traverse. At these stations, the surveyor measures the width of the cross-section and the slope between each station. In the field, these stations are placed at breaks in the topography, and not necessarily on even intervals. The information gathered at each cross-section will then be used to calculate the optimal L-line road location. In office calculations, the only constraint on how far a road can be offset from the original P-line is the limit of the information from the cross-section survey. Off-setting beyond the area of this surveyed cross-section would involve guesswork as to the terrain, etc. In this case, it might be necessary to return to the site for further surveying or to relocate a road section.

After the L-line design has been established by the P-line and from office calculations, the L-line is surveyed on the ground to establish construction control (Figure 5-5). The prescribed clearing limits are then measured from the cut and fill slope stakes.

CONCLUSION

Proper location is key to providing a cost-effective and environmentally acceptable road. The landowner should control the road location process and review the road location on the ground with the road contractor before road construction commences. A consulting forest engineer should be hired to review difficult or questionable road locations.

Road construction control becomes more important where complex topography creates more environmental challenges and more construction difficulties. A professionally engineered road design and construction staking may be warranted on ground where a large amount of earth must be moved or on environmentally sensitive locations.

Forest roads can be a costly long-term investment. In the Pacific Northwest region, several licensed professional forest engineering firms are available to assist the landowner in all aspects of timber harvesting. A listing of regional forest engineering firms is in the Appendix. The money spent up front could yield savings in the future. It is paramount that roads be properly located to minimize the cost and environmental impacts.

INTRODUCTION



Figure 6-1. Roadway failure due to lack of proper maintenance.

Because of natural wear and traffic, a road must be maintained periodically. In adverse weather conditions, a road may require regular maintenance, especially a road with a ditch. A road causes an unnatural change on the natural landscape. Over time, nature will continuously work toward reestablishing a natural landscape. Figure 6-1 illustrates road deterioration caused by erosion and lack of proper periodic road maintenance.

In addition to natural damage, traffic damage not quickly repaired can seriously erode a road. The wheel rutting illustrated in Figure 6-2 could cause serious erosion during a rainstorm, damaging both the road and the environment as surface runoff is channeled down the wheel ruts, which increases the erosive power of the water and can channel sediment into nearby streams. Damaged culverts can also cause serious roadway erosion. In addition, standing water in ruts can saturate the subsurface, especially if it is allowed to sit for a long time.

This can cause the road to fail or the fill to slough off. Effective road maintenance can preserve roads, keep down a landowner's long-run costs, and help reduce the impact on the environment.



Figure 6-2. Excessive wheel rut damage to the road surface.

An effectively managed road has a well-maintained surface, clear and well-maintained drainage, and effective erosion control. The road in Figure 6-3 is an all-weather, aggregate-surfaced, ditched road. Ditched roads require regular maintenance at least annually and after each serious rainstorm, or after snow runoff in high country. Here, the surface is well maintained to provide proper surface drainage, and the ditch and relief culverts are maintained and kept clear of obstructions to provide for maximum flow. There is little evidence of erosion.

The outsloped, aggregate-surfaced, all-weather road shown in Figure 6-4 is well designed and constructed. This minimum impact road has remained continuously open to traffic after timber harvest operations were completed, even though it has not been maintained in the last 2 years.

It is worth highlighting that the ditched road shown in Figure 6-3 must be maintained periodically, though the outsloped road shown in Figure 6-4 had not been maintained in over 6 years after the completion of timber harvest operations. Fur-

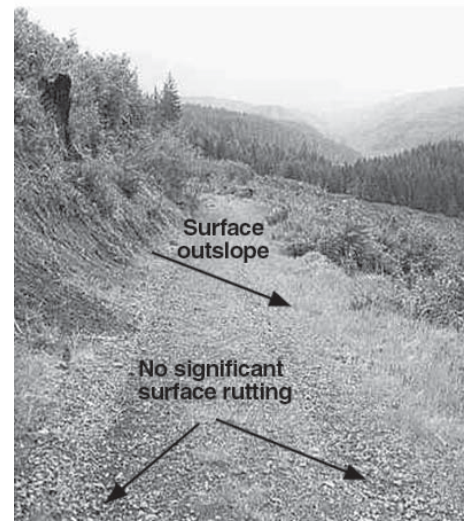
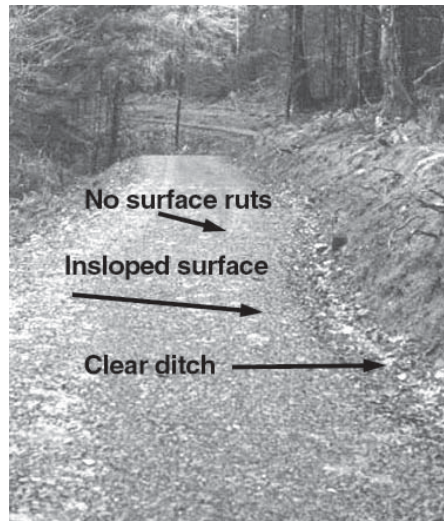

Figure 6-3. A well-maintained ditched road. Figure 6-4. A well-maintained outsloped road.

thermore, the slough (sliding off) on the cut bank visible on the outsloped road in Figure 6-4 has no effect on road surface drainage. This does not imply that an outsloped road will never need maintenance. The landowner should periodically clean off the slough to keep it from migrating onto the road surface. However, this type of damage is much less serious than a blocked ditch on an insloped road. On a ditched road, this amount of slough would have to be removed immediately because it could block the ditch, forcing the ditch water onto the road surface, and quickly causing serious erosion.

ROAD SURFACE FAILURE

All native-surfaced and rock roads depress under vehicle wheel loads, never completely returning to their original shape (Figure 6-5). This is how ruts develop on road surfaces over time. A road surface may rapidly develop ruts if the subgrade or surface courses are improperly constructed or maintained, or if they carry overweight wheel loads for the existing road surface conditions.

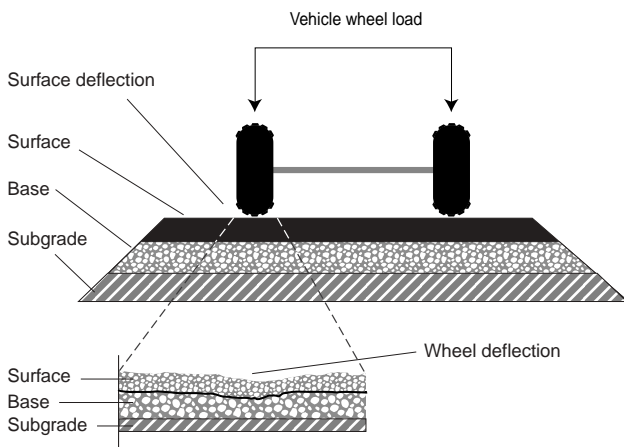

Figure 6-5. Rutting of a rock road surface.

Because a combination of factors may damage a road, it can be difficult to determine why aggregate or soil-surfaced roads fail. Often, when signs of surface distress are detected, the entire road surface structure (the subgrade, base, and surface course) has already failed from invisible damage under the road surface.

One mode of failure is called shear failure, where the wheel load is too heavy for the road surface to support, and thus the surface material punctures into the subgrade (Figure 6-6). This type of surface failure is difficult to detect; often the only indication is small

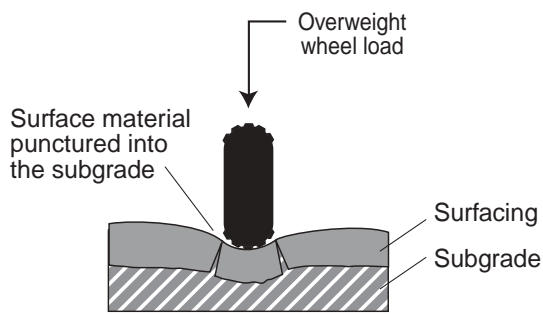

Figure 6-6. Shear failure of a road surface because of overweight wheel loads.

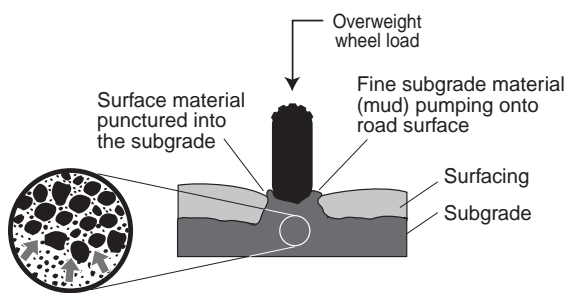

Figure 6-7. Migration of moisture-saturated subgrade soil particles into rock surfacing.

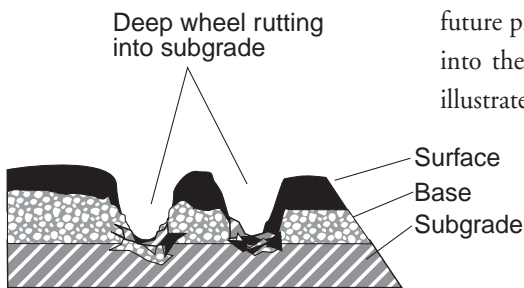

Figure 6-8. Excessive rutting on a base- and surface-rocked road.

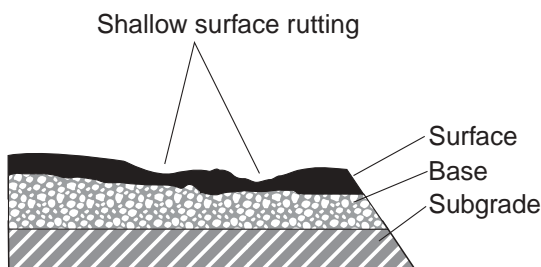

Figure 6-9. Shallow rutting that can be maintained with a motor grader.

wheel ruts in the road surfacing. Shear failure can be avoided by adequately designing surface rock depth and by insuring that hauling vehicles are not overloaded.

Traffic wheel loads on a saturated subgrade cause a second mode of road surface failure called pumping (Figure 6-7). The problem begins when the subgrade becomes saturated from standing water that seeps in horizontally from a blocked ditch, or vertically from wheel ruts. Moisture in the saturated subgrade is pumped up into the road surfacing when the subgrade soil is squashed from a wheel load and saturated soil particles migrate into the more-porous aggregate surfacing. The moisture and fine soil particles act as a lubricant, destroying the strength of the subgrade and surfacing. To avoid this type of damage, landowners should prevent standing water by keeping ditches free of obstructions and regraded roads to remove ruts. Under extremely wet conditions, the landowner or road contractor may need to close the road until the area dries.

VEHICLE DAMAGE AND SURFACE MAINTENANCE

Unfortunately, damage to the roadbed or subgrade and surfacing layers can be hidden by routine maintenance. For example, on aggregate-surfaced and earth surfaced roads, damage to the subgrade can be hidden when the road surface ruts are reshaped and smoothed over by a grader. This situation can cause serious future problems if the material in the ruts has pumped saturated subgrade soil (mud) up into the base or surface layer. The mixing of saturated subgrade base and surfacing is illustrated in Figure 6-8.

This type of damage can cause continual rutting problems as the road loses material strength in the wheel ruts. In severe cases, the wheel ruts must be excavated and the base and surface rock replaced, which is an expensive operation.

To avoid this, landowners should regulate forest road traffic during extreme wet weather. Vehicles, particularly heavy trucks, can cause this type of damage on one pass down a road.

NORMAL ROAD SURFACE DEFORMATION

Some types of road surface deformation affect only the surface layer. Shallow rutting and washboarding (corrugations) are limited to the surfacing material and do not penetrate into the base course (Figure 6-9).

Washboarding is caused by the forward and downward motion of a vehicle's wheels breaking or bouncing on the road surface, which can begin to form small corrugations on the surface layer perpendicular to the direction of the road. Washboarding can usually be corrected by reprocessing (reshaping) the surface rock. This is accomplished by shaving off a layer of the road surface rock with a road grader, then laying it back down and recompacting it. Washboarding and other shallow rutting is classified as normal deterioration that generally requires only routine maintenance.

The following indicates normal deformation of the surface layer:

- It is easily observed prior to blading.
- It is corrected by routine blading and reshaping.
- Ruts more than 6 inches deep can indicate more serious problems with the base and subgrade, and the road surface should be reshaped as soon as possible if it has ruts of between 2 and 6 inches (at 2 inches, ruts are easy to see and are sufficiently deep to carry a potentially damaging amount of water).

ROADWAY DRAINAGE MAINTENANCE

The first three concerns in road design, construction, and maintenance have been often stated as *drainage*, drainage, and **drainage**. Poor drainage can be a road's worst enemy. Moisture affecting road performance comes from four main sources: road surface runoff, blocked ditches, blocked culverts, and underground water tables or water-bearing strata. Any of these can cause deterioration and weaken the road structure.



Figure 6-10. Catastrophic ditch and roadway erosion.

Rain and snowmelt must be removed from the road surface as rapidly as possible because moisture can soak through the surface into the subgrade. Road surface geometry is designed to divert surface runoff as rapidly as possible, whether the road is crowned, insloped, or outsloped. A ditch gathers and concentrates runoff; similarly, ruts (which channel water like a ditch) can render outslope drainage ineffective.

Improperly shaped road surfaces include ruts, plugged ditches, or berms left by a road grader on the outside shoulder of a road. These conditions can cause erosion, or cause water to pool and infiltrate the road surface, weakening the subgrade and causing potholes and ruts.

DITCH AND CULVERT MAINTENANCE

Relief culverts drain ditches at periodic intervals. Without proper or timely ditch maintenance, a road can be catastrophically damaged. Figure 6-10 shows how plugged culverts cause catastrophic ditch and roadbed erosion into the subgrade.

On ditched roads, the ditch relief culvert inlets should be kept clear to provide for maximum drainage efficiency. Ditch catch basins should be cleaned of debris and



Figure 6-11. Significant ditch erosion.

the ditch blocks maintained. In some cases, ditches can be kept free of obstructions with a shovel. In other cases, a backhoe, motor grader, or loader must be used, with a dump truck to haul away the slough or berms left from maintenance of the road surface. Sometimes relief culvert inlets and outlets are smashed and need to be formed back into round, or replaced. Plugged and damaged relief culvert inlets can cause the water in the ditch to flow over ditch blocks, increasing flow volume and erosive power. When relief culverts are severely plugged, they can be cleared with water from a high-pressure fire hose (with great care in the vicinity of streams). In minor cases or with regular maintenance, culverts can be kept clear by hand. Unchecked, any of these problems can cause significant damage to any type of road (Figure 6-11).

There are several methods to stabilize soil in relief ditches and to reduce the force (velocity) of the water, including armoring the ditch with rock, growing grass in the ditch bottom, or installing drain relief culverts at more frequent intervals.

STREAM-CROSSING STRUCTURES

It is very important to properly maintain structures that cross streams, whether bridges or culvert pipes. These structures often represent a large investment. Timber bridges should be inspected periodically for damage caused by vehicles, insects, rot, or flooding. A professional engineer should inspect damaged bridges and perform a vehicle load rating analysis to determine whether the bridge is safe to carry the intended traffic loads.

Similarly, culverts should be kept free of blockage and inspected periodically. Because stream-crossing culvert pipes are placed under road fills, when culverts fail, considerable sediment from the road fill can be transported directly into the stream (Figure 6-12), which can seriously harm fish habitat and water quality. The entire fill around and over the culvert in Figure 6-12 has been completely eroded into the stream channel. This occurred when the inlet became plugged and the stream ran over the top of the fill, destroying it. Again, it is important for the landowner to carefully maintain and clear out ditches and culverts to avoid this financially and environmentally costly situation.



Figure 6-12. A complete fill washout because of a plugged culvert inlet.

Trash racks can be used efficiently to catch debris before they block the inlet of a stream culvert. These should be carefully designed to provide for machine access if needed for clearing the debris from the structure (Figure 6-13). When necessary, trash racks should be constructed with enough room around them to allow backhoe access; a side approach might be needed in a deep fill to allow backhoe access. Trash racks can be costly to construct and maintain.

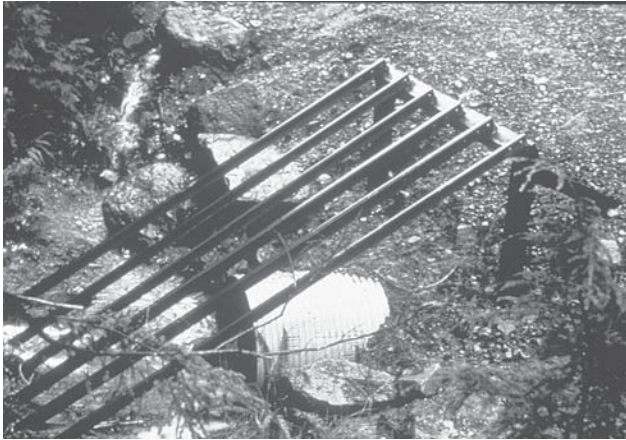

Figure 6-13. Culvert inlet trash rack.

Stream culverts can be difficult to maintain when regulations require that woody debris must be left in fish-bearing streams. On some streams, keeping culverts clear of debris can be a serious problem. Thus, if possible, culverts should be designed with enough room to allow a certain amount of debris to pass unobstructed during a peak flood. Culverts, like bridges, should be designed by a professional engineer to reduce future maintenance problems, to protect the environment, and to meet all required regulations. Bridges are generally more effective than culverts in providing fish passage and in passing larger quantities of flood debris. However, depending upon the size of structure required, bridges are usually more expensive than culverts.

TRAFFIC CONTROL

The ability to effectively close roads to all vehicle traffic when the road surface or subgrade is saturated can be critical in reducing costly maintenance and help control surface rutting, standing water, roadway erosion, and serious turbidity in streams. Potentially severe road damage can occur with one vehicle pass during extremely wet weather. Wet-weather traffic can also quickly escalate road maintenance costs, such as would be necessary for the severe rutting shown in Figure 6-2 (p. 47).

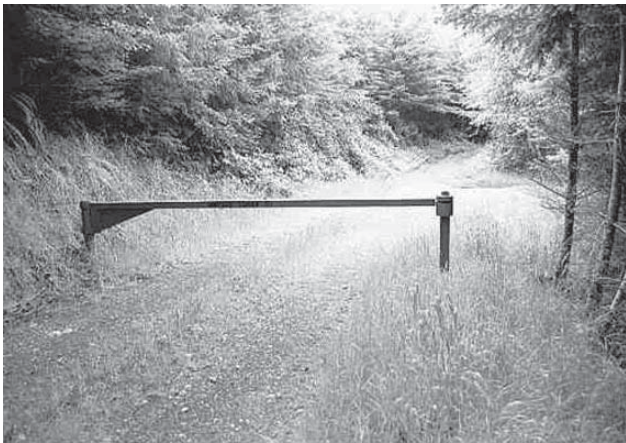

Figure 6-14. A forest road vehicle gate.

Gates are often used as an effective method to control forest road access (Figure 6-14). To be effective, gates must be located so that it is difficult or impossible to drive vehicles around them. This can be accomplished by locating them in a narrow break in a dense forest or beside any other natural feature that can block access around the gate. Access around gates can also be blocked with deep ditches called “tank traps,” to preclude vehicle passage. A gate must also be strong enough to discourage vandalism, especially if it is in a remote location.

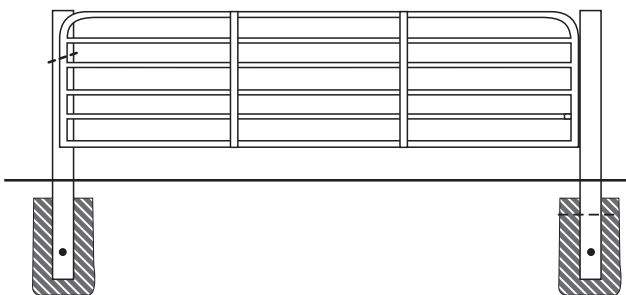

Figure 6-15. Basic Powder River Gate.

The shop-fabricated gate in Figure 6-14 has steel posts sunk in concrete and a steel gate padlock box, which make it more vandal-proof than other types of gates. This type of shop-fabricated gate has been successfully used to secure remote forest roads in the Coast Range of western Oregon. A shop drawing for building and installing a gate of this type is provided in the Appendix.

The Powder River gate is another possibility for closing forest roads (Figure 6-15). This commercially fabricated gate is often used between cattle enclosures on farm and ranch roads. The widely used

Powder River gate can be readily purchased; however, because it is usually constructed with wood posts and without a gate lock box, it is more easily vandalized. A shop drawing for the installation of this gate is included in the Appendix.

Even with a gate, it can be difficult to control access for all four-wheel-drive vehicles. During the critical wet season it may be necessary to increase control of vehicle access. For this, a landowner might consider working with neighbors and local law enforcement officials.

HOW TO WRITE A SUCCESSFUL CONTRACT TO CONTROL ROAD CONSTRUCTION AND RECONSTRUCTION

INTRODUCTION

In this section, road-related timber sale contract information is discussed to assist the landowner in creating a well-drafted road section of a timber sale contract. Effective road-related language in the timber sale contract is essential to achieving the landowner's objectives. A lumber company or logger may or may not have the landowner's interest in mind—the contractor's preliminary interest is often to get out the timber as efficiently and inexpensively as possible. Though contractors must follow regulations, the way they construct a road will not necessarily conform to the landowner's interest in minimizing long-term costs or environmental impact. Thus, landowners are advised to carefully develop a binding contract to guide road construction and maintenance during the contract period.

Depending upon the landowner's operational needs, a road may be built by a road construction contractor or a logging contractor. In the Pacific Northwest, roads are usually constructed late spring through early fall, weather permitting. Because of this timing, roads are often built under a road contract, and the harvesting is accomplished under a separate contract. When both the road construction and timber harvest operation are under the same contract, the timber company may subcontract the road construction to a third party.

A road construction contract is a legal document. Whether a landowner contracts directly with a road contractor or sells timber on the stump to a logging company (which in turn might hire a third-party road construction contractor), the document should provide enough engineering information, written in plain English, to assure the landowner's road management objectives will be met. This will help both parties gain a common understanding of the necessary road-related work to be accomplished through the logging contract. To help the landowner achieve this, the following road elements and standards are established for low-speed, single-lane forest roads, the type of road most small woodland owners construct.

TYPE OF ROAD TO BE CONSTRUCTED

The ditched and the outsloped road are the two types of single-lane, low-speed, low-traffic-volume roads that are generally constructed. Depending on the type of road the landowner

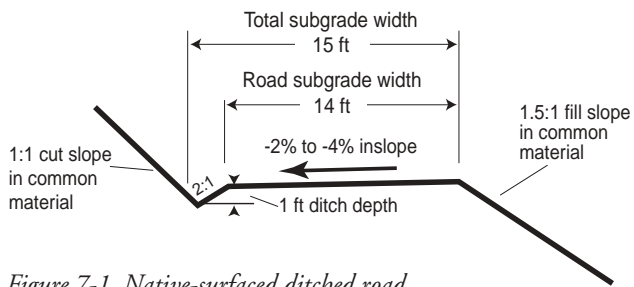

Figure 7-1. Native-surfaced ditched road.

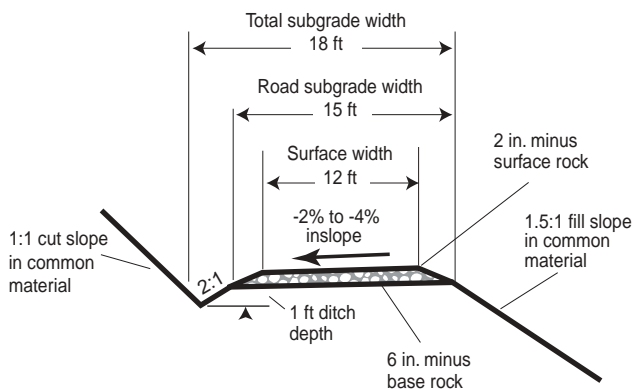

Figure 7-2. Aggregate-surfaced ditched road.

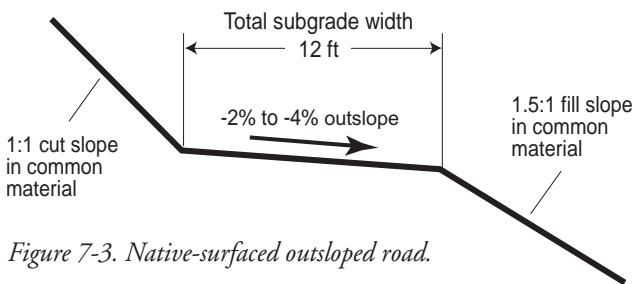

Figure 7-3. Native-surfaced outsloped road.

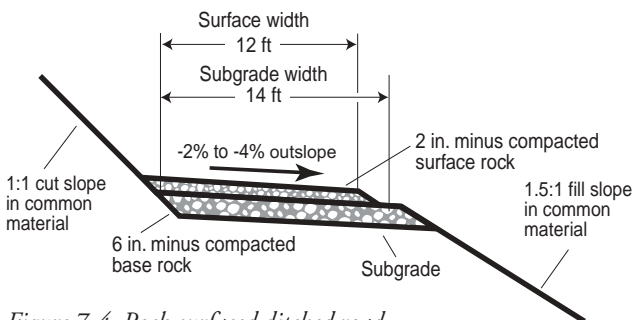

Figure 7-4. Rock-surfaced ditched road.

chooses, a road template schematic should be placed in the timber sale contract to assure the road is constructed to the necessary dimensions. Example schematics are illustrated in Figures 7-1, 7-2, 7-3, and 7-4. Landowners can use one of these templates, depending on whether they choose an insloped or outsloped road and whether they have decided on a native soil or aggregate surface. These templates also appear in the Appendix with the dimensions left blank to be filled in prior to placing the template in the contract.

The dimensions given in these figures are generally applicable. Again, however, the surfacing on roads can vary. For example, compare the dimensions for the native surfacing shown in Figure 7-1 to the all-weather rock surfacing shown in Figure 7-2. Note also that the dimensions will not apply to a curve. Curves are widened by varying amounts, depending on the vehicle using the road and its off-tracking, the curve radius, and the deflection angle. The cut and fill slopes can vary, too, with different road materials. For instance, in solid rock, it is possible to construct a near-vertical cut slope, or with rock aggregate a relatively steep cut slope of 0.5:1 to 0.25:1, in contrast to a cut slope in common material of 1:1 or 0.75:1. Similarly, a fill slope constructed with rock, in appropriate conditions, can be steeper (1.25:1) than a native soil (common) fill slope (1.5:1, and in some instances on relatively shallow fills, 1.33:1), as shown in figures 7-1 to 7-4.

INITIAL CLEARING OF THE ROAD CORRIDOR

CLEARING

Depending on the specific situation, roadway merchantable timber must be felled, stacked (“decked”), and/or removed from the road project prior to major grubbing and slash disposal operations. An efficient contractor will do this. To assure this is accomplished, contract language could read

All merchantable right-of-way timber will be felled, bucked, decked, or removed from the road project prior to roadway excavation.

GRUBBING

Grubbing is the digging and removal of stumps and roots within the clearing limits of the roadway. In the process, the duff is cleared

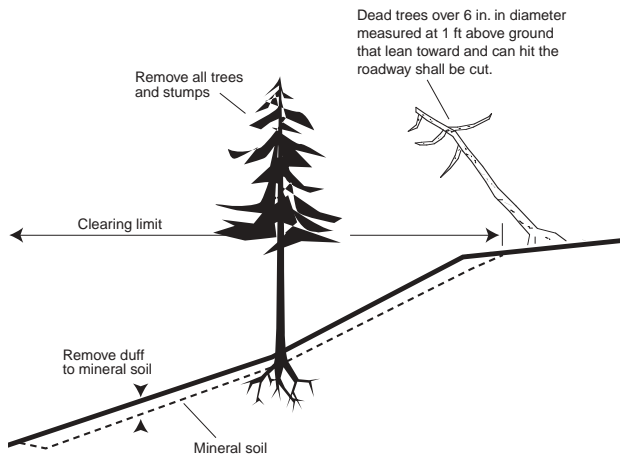

Figure 7-5. Clearing and grubbing requirements.

off the road prism down to mineral soil. In doing this, the roughed up subsoil better adheres to the fill material. The grubbing specifications in Figure 7-5 are adequate to avoid future maintenance problems related to road subgrade and surface stability on steep ground.

Contract language could read as follows:

Grubbing shall be accomplished to the specifications of exhibit number _____. (Use Figure 7-5 as the exhibit.)

SLASH DISPOSAL

A slash disposal method or combination of methods can be used, depending on specific ground conditions and the landowner's management objectives. Slash may be buried, burned, ground into mulch, windrowed along the base of the slopes, or scattered. Scattering slash is generally the least expensive method of disposal. Example contract language for scattering slash in logging units could read

Roadway slash, created from grubbing, cutting, and limbing of trees and brush, shall be scattered outside the clearing limits without causing tree damage. No slash will be buried within the clearing limits. Slash will be placed away from standing trees' cull logs and in a stable position to prevent logs from rolling. All unmerchantable logs shall be limbed. Slash will not be concentrated in piles. It will be placed so that it will not hinder reproduction planting.

EARTHWORK

PIONEERING

The following are recommended specifications to assure an adequate pioneering road is constructed and the cut slope is not undercut:

Pioneering excavation operations will be confined inside the roadway's catch points.
Drainage will be maintained at all times.

EXCAVATION

All suitable excavated material should be incorporated into fills. Excess excavation and unsuitable material should be wasted (moved to a suitable and agreed-upon location) outside the road prism. The following language can be used to guide excavation in the contract:

Prior to excavation excess excavation and unsuitable material shall be wasted at agreed-upon stable waste locations outside the road prism.

EMBANKMENT

There are two common methods used for placing and compacting excavated material, side casting and end haul dumping. Side cast excavation is where excavated material is simply pushed from a road cut to an adjacent fill area. End haul dumping is loading and hauling cut material (often in dump trucks) to a fill location, sometimes distant. Side casting is generally used on gentler slopes and shallower fills. Side cast material should be layer-placed and adequately compacted. (A side cast onto a sliver fill is unacceptable, as are all sliver fills, because it is impossible to adequately compact them and they can fail over time.) End hauled material should also be layer-placed and adequately compacted. Whichever method is used, the objective is to construct a stable roadbed (subgrade) that will minimize future maintenance, soil erosion, and road failure. To achieve this stability generally requires layer placing and adequate compaction of fills.

Layer placing means the road structure is built up one layer at a time so that the road material compacts more easily and efficiently. At a minimum, the road contractor should layer place fill material and operate the spreading equipment uniformly across the fill by overlapping equipment tracks as the spreader works back and forth. This will provide a degree of compaction in the fill. The following specifications can be used to enhance the stability of the embankment, whether end haul or side cast:

- Areas with cross slopes in excess of 20% shall be roughened to provide a bond with fill material.
- Embankment shall be layer-placed in 1-foot lifts. Each lift will be uniformly spread across the full width of the fill. Hauling and spreading equipment shall be operated uniformly across the fill by overlapping equipment tracks as they work back and forth.

Though it is more expensive, a landowner might also require in the contract a mechanical roller (possibly on deep fills or roads with a substantial amount of traffic), such as a smooth-wheel vibratory roller or a sheep-foot roller. The smooth-wheel vibratory roller simply works the lift (layer) of soil until it is adequately compacted. The sheep-foot roller has a series of small feet on a drum that each applies a certain compaction force. The lift is worked until the feet emerge (no longer sink into the surface). It is important to understand that different soils compact most efficiently with different types of rollers and compaction equipment. An engineer or a supplier of compaction equipment should be able to provide this information.

PLACING EMBANKMENT ON WET GROUND

The following specifications can be used to build a stable fill foundation on wet, swampy ground.

-
- On wet ground, the fill shall be constructed of suitable material in a single layer to a minimum depth that will support the construction equipment.
 - Fill material shall be free of snow and ice.

ROADBED SUBGRADE FINISHING FOR ROCK AND NATIVE SOIL SURFACES

With an aggregate subgrade, the finished roadbed should not have large rocks (larger than 4 inches) protruding from the surface. For both rock and native subgrades, the surface should be graded to the appropriate road surface template and compacted to the owner's specifications. On wet ground, aggregate can be added or geotextiles or other methods can be requested. In any case, suitable soil should be used. Contract specifications to help accomplish this are

- The top 6 inches of road surface shall not have rocks larger than 4 inches in the largest dimension.
- Soil with a high percentage of clay or silt will be excavated and replaced with a suitable mineral soil free of snow and ice, grubbing debris, and surface duff.
- The finished subgrade will be compacted.
- Fill material will be suitable mineral soil free of foreign material, snow and ice, grubbing debris, and surface duff, that is layer placed in 1-foot lifts. The layer will be uniformly spread across fills and compacted by overlapping equipment tracks as the spreading equipment works back and forth across the fill.

NATIVE-SOIL SURFACING

For dry-season logging, the road surface can sometimes be constructed from native soil, depending on the type of soil at the site, the road grade (and traction necessary), the amount of traffic anticipated, and the season of use. The contract as written above will already be adequate for native-soil surface if it requires suitable soil (and excavating unsuitable soils, if necessary) as well as compacting in layers.

ROCK SURFACING

Wet-season logging requires an all-weather surface, such as aggregate rock surfacing. One difficulty landowners face in constructing (and paying for) an all-weather surface is verifying the quantity of rock they have purchased for their roads. The units of measure are by the cubic yard or ton weight. Two common methods are used to verify rock volumes delivered. Rock trucks can be weighed and scale tickets provided to verify each truckload, or the original rock stockpile can be measured before and after all the rock is re-

moved. However, each of these methods of verification can add cost and time to the procedure of hauling rock, and they require close monitoring. Furthermore, to properly calculate quantities delivered, it is important to understand that rock trucks are not usually loaded to their full capacity when hauling because of highway weight restrictions and the impracticality of fully loading a truck. Instead, trucks are generally loaded to about 85% of their maximum box volume (for example, a 10 cubic yard dump truck will carry about 8.5 cubic yards of rock). The percent load factor also varies, depending on the configuration of truck boxes and load limits.

The following contract language gives both methods of verification, though a landowner can choose one over the other. In either case, the landowner can demand accountability for quantities delivered.

- The contractor will provide the landowner with a net weight load trip ticket for each load of rock delivered.
- The rock stockpile will be measured before and after the total amount of rock is delivered to the designated site.

To maximize its effectiveness, rock surfacing must be properly placed under ideal conditions whenever possible. The subgrade must be well compacted and the subgrade surface bladed with a road grader. The road grader cuts the final finished grade before the rock-ing operation begins. The final compacting and grading is an important function because it establishes the finished subgrade surface to provide proper road surface drainage after aggregate surfacing is placed on the road. These ideal conditions include a proper gradation of fine and larger rock, a proper moisture content and thickness of the rock layers, and an adequate level of compaction.

When aggregate is placed on the subgrade, there should be no segregation. That is, the fine and larger rock material should remain evenly mixed. There is also a maximum thickness or depth for any one layer. Rock depth specifications should be based on the compacted depth of the rock. For example, 3-inch-minus rock should be added in a single, compacted lift (layer) 3 inches deep. As with the common material for the subgrade, surface rock has an optimum moisture content, which can be determined by laboratory tests to attain maximum compaction. If this laboratory test is used, the moisture content of the delivered rock is field tested and compared with the laboratory optimum. If the rock is too dry when placed on the subgrade, water must be added by using a water truck. If it is too wet, it must be windrowed back and forth across the subgrade surface to remove excess moisture. Finally, to attain maximum compaction, the rock should be mechanically compacted, ideally (if funds allow) by using a smooth-wheel vibratory roller.

Because the “ideal” is so costly for the average private landowner, a combination of the following specifications can be used to attain adequate, if not ideal, rock surfacing. After receiving an estimate from the road contractor, the landowner can decide which of the following to add to the final contract language. The requirement of any type of mechanical roller, including the smooth-wheel vibratory roller, can be optional.

Landowners investing a significant amount of money in aggregate may also want to specify a size and grade of aggregate. Testing and certification that the aggregate is within specifications is optional, though it will be the contractor's responsibility to assure that it is. Several sizes of aggregate are used on forest roads in the Pacific Northwest. In western Oregon and Washington, all-weather roads require a solid surface base rock, such as 6-inch minus, with a running surface of finer aggregate, such as 1-inch minus rock. On steeper road grades (over 15%), finer aggregate is needed to provide sufficient truck tire traction. Often, $3/4$ -inch rock is used for this purpose.

- If rock surfacing exceeds 6 inches in depth, it shall be placed in two or more layers.
- The aggregate will be properly mixed to preclude segregation of fine and larger aggregate.
- Adequate moisture content will be maintained to provide for maximum compaction.
- Hauling equipment shall be operated over the surface of each layer to minimize rutting and uneven compaction. Equipment delivering surface aggregate shall split tire tracks between loads to compact the aggregate.
- The surface of each layer shall be graded during the compaction operation to remove irregularities and produce a smooth, even surface.

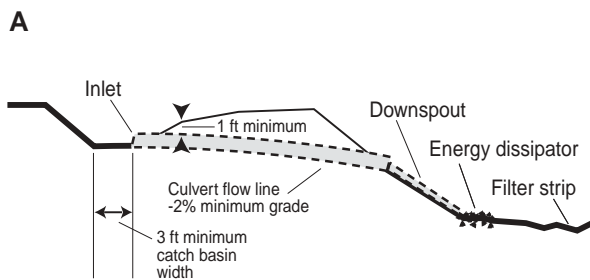

- A self-propelled vibratory roller is required to provide maximum compaction over the entire area of each rock base and surface lift.

DRAINAGE STRUCTURES

Proper installation of drainage structures is key to the integrity of the road as related to erosion potential. The following specifications address ditches, relief culverts, and drain dips.

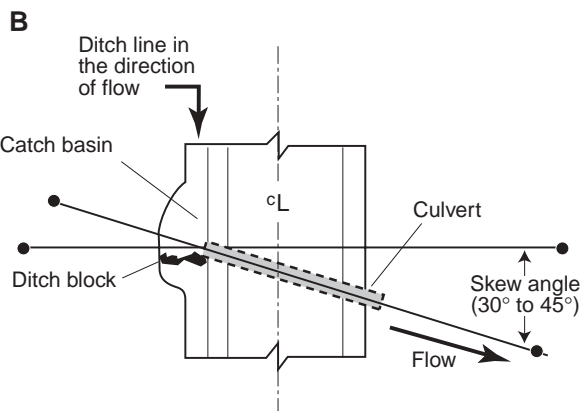

DITCHED ROADS

Adequate construction of ditches is key to proper drainage of ditched roads. The following specifications can be written into a contract:

- Ditches will be constructed as shown on the standard culvert template drawing (Figure 7-6).
- All ditches will carry a minimum grade of 2%.

Relief culverts must be properly installed to assure they function properly. The following specifications address this:

Figure 7-6. Ditch relief culvert installation.

-
- Culverts will be installed as per the standard relief culvert template (Figure 7-6).
 - The minimum skew angle of pipes on grade will be approximately 30 degrees.
 - Culverts shall be joined with form-fitting coupling bands as recommended by the pipe manufacturer. Dimpled-type culvert coupling bands shall not be used when pipe grades exceed -15% to avoid culvert sections pulling apart.
 - Backfill will be placed in 6-inch lifts (layers).
 - Backfill density will exceed the compaction of the surrounding embankment.
 - No rocks larger than 2 inches shall be in the select backfill within 6 inches of the culvert surface.
 - Ditch blocks will be constructed as shown on the relief culvert template (Figure 7-6).
 - Downspouts and energy dissipaters will be installed when culvert outlets discharge directly onto the fill slope. Downspouts will be extended to the toe of fills.
 - Ditch relief culverts will be constructed as required to assure adequate road surface drainage.
 - Ditch relief culverts will be spaced as approved in writing by the landowner prior to construction.

OUTSLOPED ROAD DRAINAGE

Adequate outsloping, as well as properly installed drain dips and rubber water bars, provide for the surface drainage of outsloped roads. This can be accomplished with the following specifications:

- The outsloped road surface shall be established as provided on the standard road template drawing for either native-soil or rock-surfaced roads (refer to Figures 7-3 and 7-4).
- Drain dips shall be constructed as required to assure adequate road surface drainage.
- The location and spacing of drain dips shall be approved in writing by the landowner prior to construction.
- The drain dips shall be constructed on grades 2%–8%.
- Drain dips shall be constructed on fills less than 6 feet in vertical elevation from the ground at the outside subgrade fill shoulder.

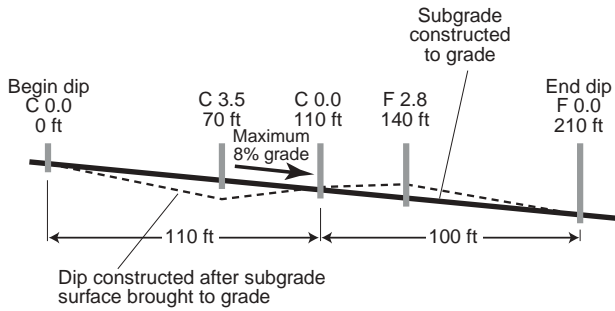

Figure 7-7. Drain dip construction survey staking example.

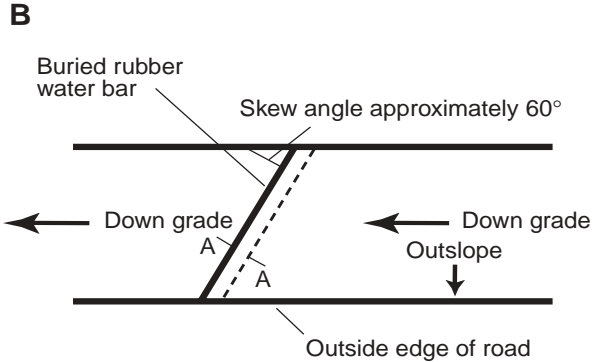
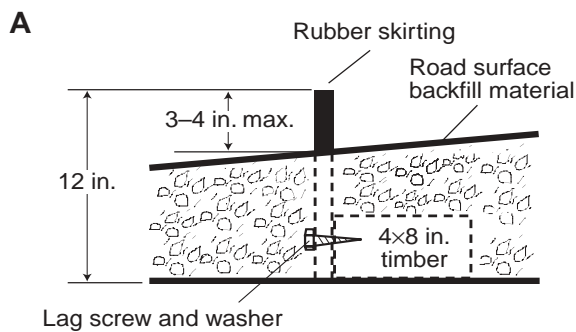

Figure 7-8. Installation specifications for rubber water bar.

- Drain dips shall be constructed to conform to the drain dip template drawing (Figure 7-7). The 210-foot total length shown in Figure 7-7 assures logging truck passage without broaching. If this is not a worry (such as after a logging operation with light pickup traffic), the minimum length of a drain dip can be 65 feet, where 35 feet and 30 feet replace the 110-foot and 100-foot sections in Figure 7-7. Refer to the discussion in Chapter 3 for Figure 3-9 and Table 3-1.
- Rubber water bars will be constructed on road grades greater than 8%. Rubber bars will be constructed as described in the water bar drawings (Figure 7-8).

STREAM-CROSSING AND DRAINAGE STRUCTURES (CULVERTS AND BRIDGES)

Contract language for stream-crossing and drainage structures can be as follows. Note that the second sentence on following regulations should be added, whether or not the road includes stream-crossing structures.

- Stream-crossing and drainage structures (culverts and bridges) that allow fish passage will be designed and installed to meet or exceed state forest regulations.
- The contractor shall construct the road to conform to all state and federal regulations.

DIRECT ROAD LOCATION

It is strongly recommended that the landowner, or the engineer under contract to the landowner, locate the road before signing a timber harvest contract. Properly locating a road depends on the type of road and the side slope of the ground. Usually the road is direct located unless large volumes of cut and fill are required, in which case a survey and design may be necessary. This is determined as the road is located. To guide and control the construction process, a contract should clearly establish the road elements and standards. For direct location, example contract language could read

- Mark the grade breaks on road centerline with flagging.
- The maximum favorable road grade shall not surpass -12%.
- The maximum adverse road grade shall not surpass +16%.
- The minimum horizontal curve radius shall not be less than 60 feet.

- The minimum vertical curve shall be of sufficient length so that logging trucks and equipment will not broach or bottom out.
- Locations of road intersections, turnouts, and harvest landings shall be approved in writing by the landowner prior to construction.
- Sensitive areas such as headwalls, wet areas, and unstable soil shall be avoided.
- The road location shall be approved in writing by the landowner prior to construction.

A landowner can also write into the contract special areas to be given special consideration during road construction and timber harvest activities.

SURVEYED ROAD LOCATION

A surveyed road will use the same language as the direct located road. However, the landowner should retain control over the final placement of the road as follows:

Final road location will be approved in writing by the landowner prior to road construction.

ROAD CONSTRUCTION CONTROL SET BY ROAD LOCATION PROCESS

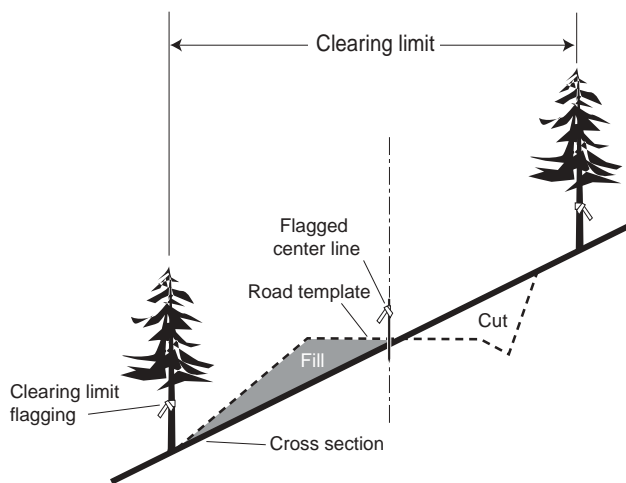

Figure 7-9. A direct-located road section.

On direct located roads, the clearing limits are often set at the roadway fill and cut slope catch points. After the road locator flags the road centerline and clearing limits for construction control (Figure 7-9), the landowner should approve the road placement and the tree removal. Contract language could read

For road _____, direct road location will establish road construction control. The road centerline and clearing limits will be flagged on the ground and approved in writing by the landowner or designated representative prior to felling of the right-of-way timber.

When a road or section of road must be surveyed and designed, construction stakes established by the survey serve as the construction control. This type of construction control is more costly than

direct location; however, construction control is much tighter. On more complicated ground where a survey and office design are necessary, we recommend that landowners contract a professional forest engineering firm to survey the area, design the road, and set the construction staking. Again, though, the landowner should still have final say over the location. Contract language to attain this level of construction control could read as follows:

Location, survey, and design of road _____ will be executed by a registered forest engineer. The road will be construction staked on the ground to maintain construction control. The plan, profile, and cross sections will be approved in writing by the landowner or the designated representative prior to the commencement of the clearing operation.

MAINTENANCE CONSIDERATIONS

The contractor should be responsible for road maintenance while the contract is in effect. To insure that these responsibilities are met, the following language can be added to the road contract:

- Maintenance of the road during the span of the contract is the responsibility of the contractor. Road shall be maintained so that a pickup truck can pass at all times.
- Damage caused to the roadway and road structure by the contractor's operations will be repaired to at least the condition the road was in before operation started.
- Contractor damage will be repaired at the contractor's expense prior to the closing of the contract.

EROSION CONTROL

Though erosion control must be maintained at all times during the life of a road, roads are especially susceptible to erosion during construction. To assure proper erosion control, add the following to the contract language:

Erosion control will be maintained at all times during construction by providing for adequate roadway drainage and sediment blocks, such as hay bales or fabric.

SEEDING AND MULCHING

Landowners often seed and mulch using a hand spreader. We recommend that landowners contact their state country forestry Extension agent to obtain the information related to ground cover that is acceptable and the appropriate application methods.

ACCESS CONTROL

Access control to private forest land must be maintained to prevent vandalism and road damage. During construction, the contractor should be responsible for maintaining access control while working on the property:

The contractor shall maintain access control while operating on the property. Gates will be locked when the contractor is not working.

FINAL ROAD RESTORATION AFTER LOGGING

The contractor should be responsible for roadway restoration after harvest operations are completed. Contract language to assure the road is in good repair after harvesting can read as follows:

- The road surface will be restored to the original contract template.
- All roadway ditches will be clear of debris and provide drainage with no standing water in the ditch line.
- All damaged culverts and other drainage structures will be either repaired or replaced.
- Damage to cut and fill slopes will be repaired.

STANDARD ROAD CONSTRUCTION AND RECONSTRUCTION TEMPLATES

The following standard blank templates (Figures A-1, A-2, A-3, A-4 and A-5) are provided for use in timber sale, road construction, or road reconstruction contracts. Landowners can modify these drawings as necessary. Note that the templates in Figures A-1 and A-4 are for native-surfaced roads, while Figures A-2 and A-5 show templates for rock-surfaced roads.

STANDARD DITCHED ROAD TEMPLATES

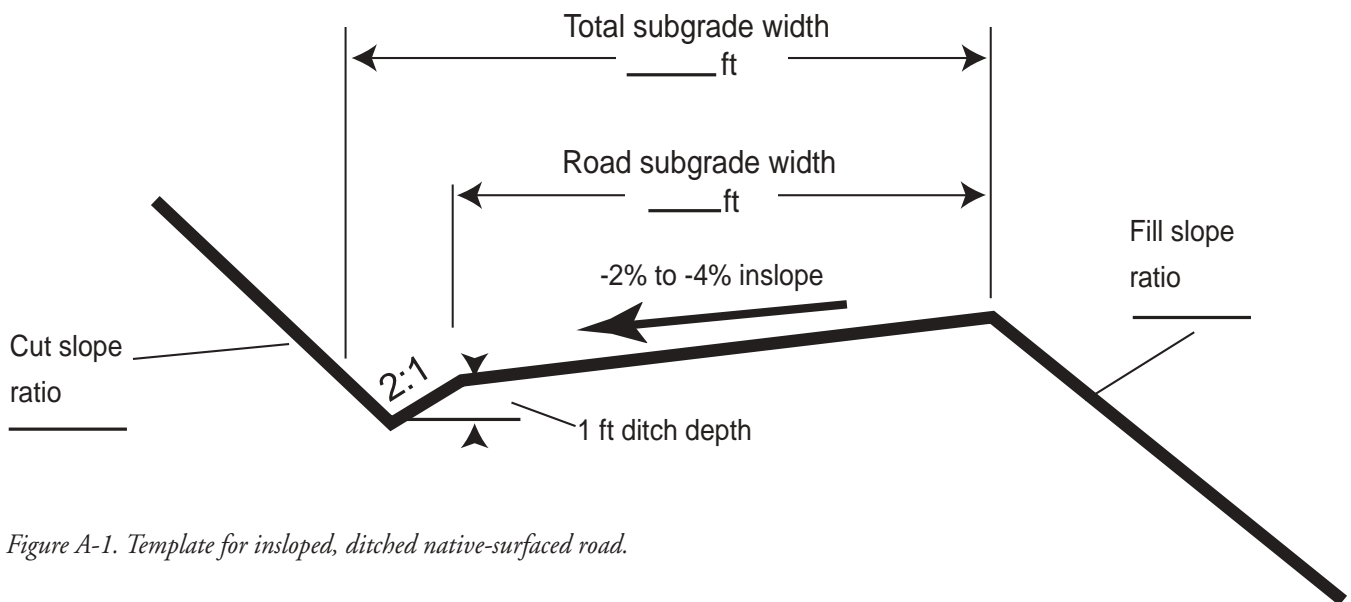

Figure A-1. Template for insloped, ditched native-surfaced road.

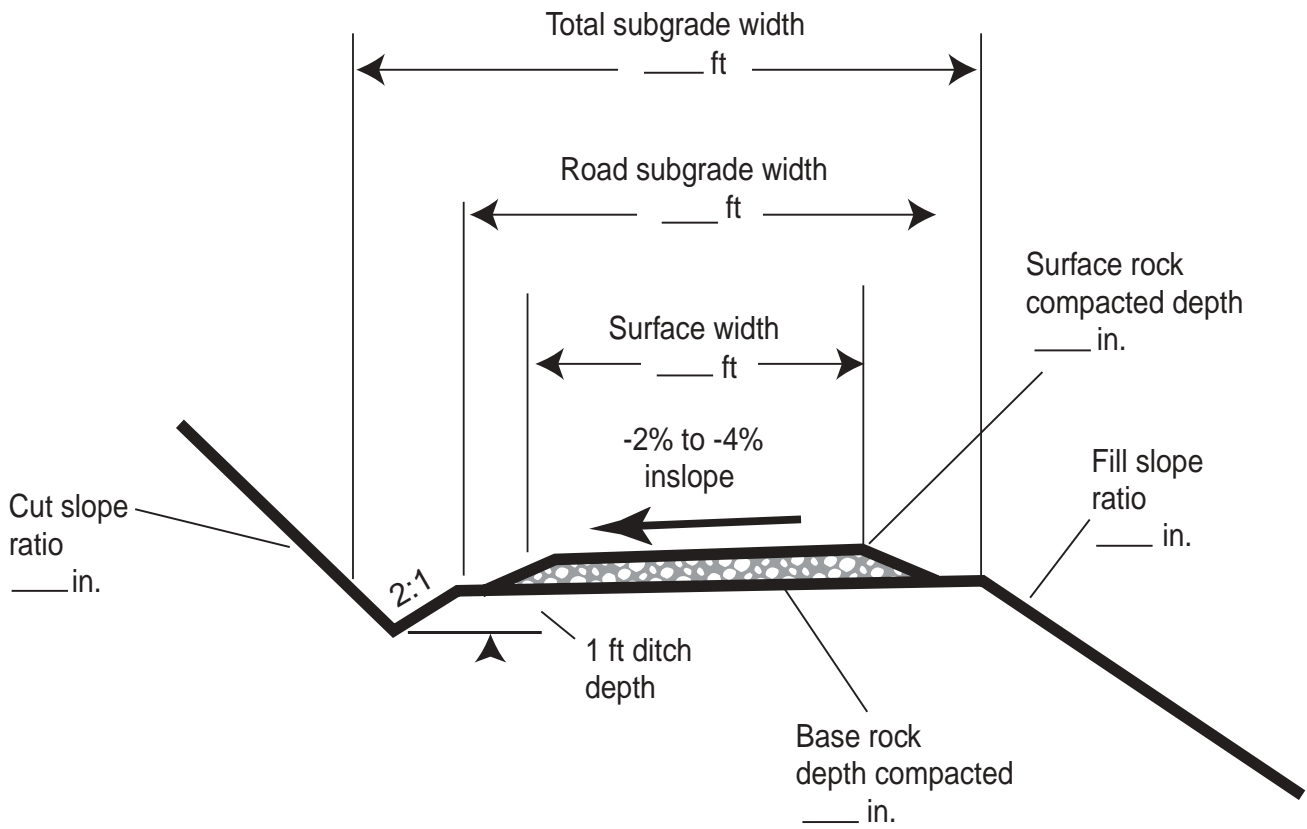

Figure A-2. Template for insloped, ditched rock-surfaced road.

STANDARD DITCH INSTALLATION

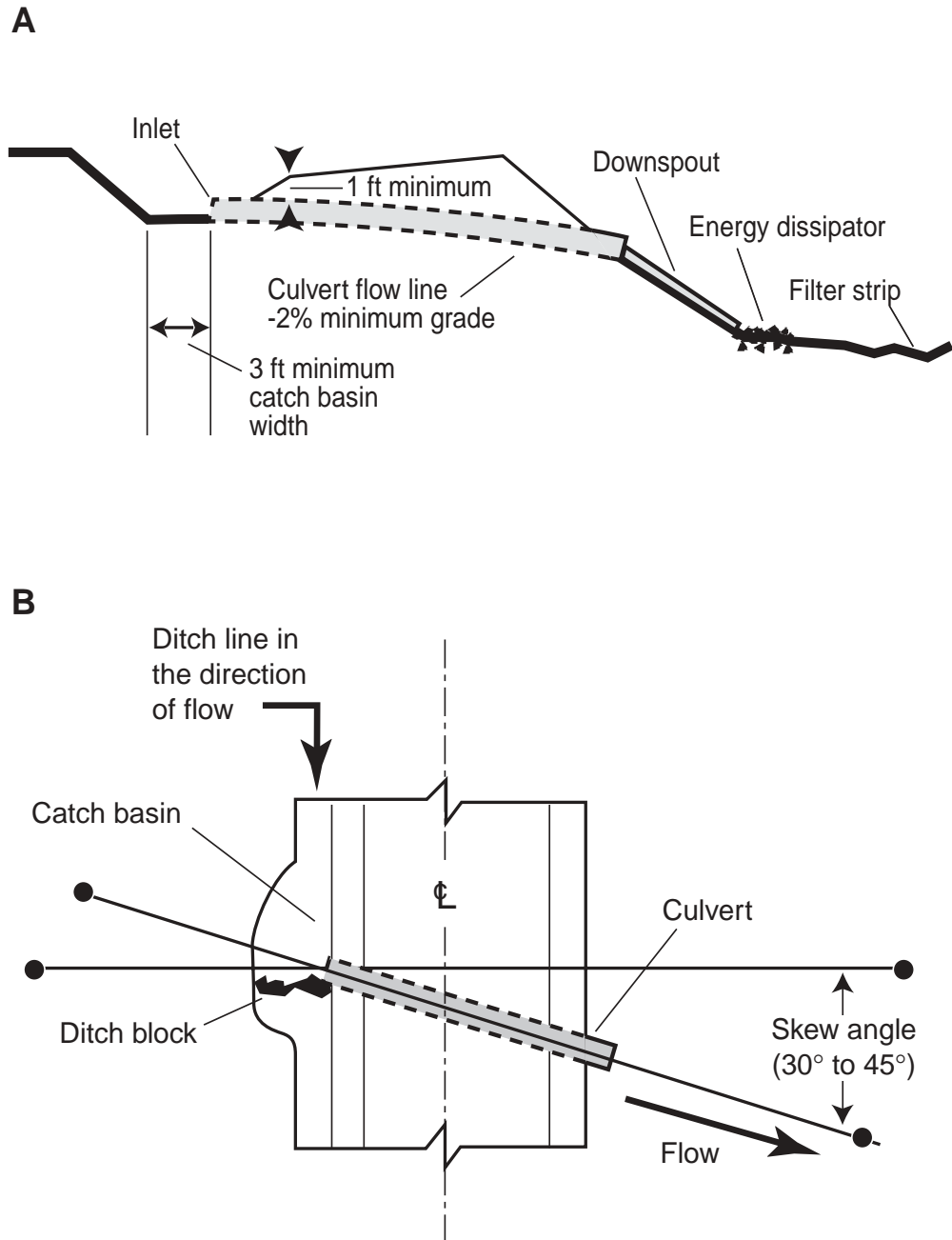

Figure A-3. Specification template for ditch relief culvert installation.

OUTSLOPED ROAD TEMPLATE WITH BASE AND SURFACE ROCK

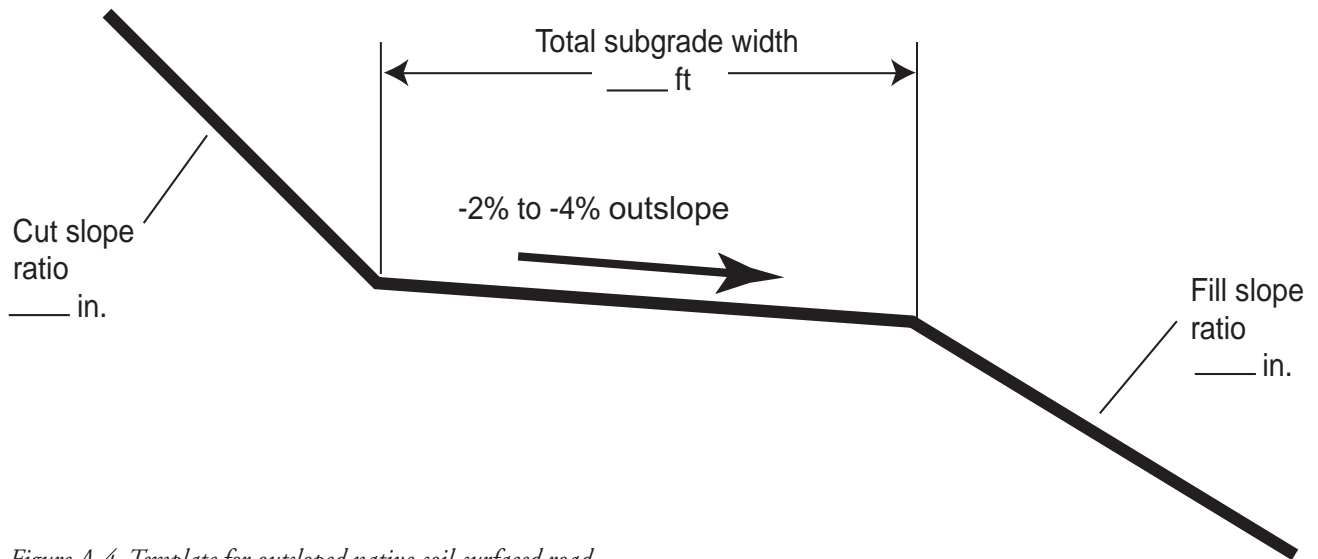

Figure A-4. Template for outsloped native-soil-surfaced road.

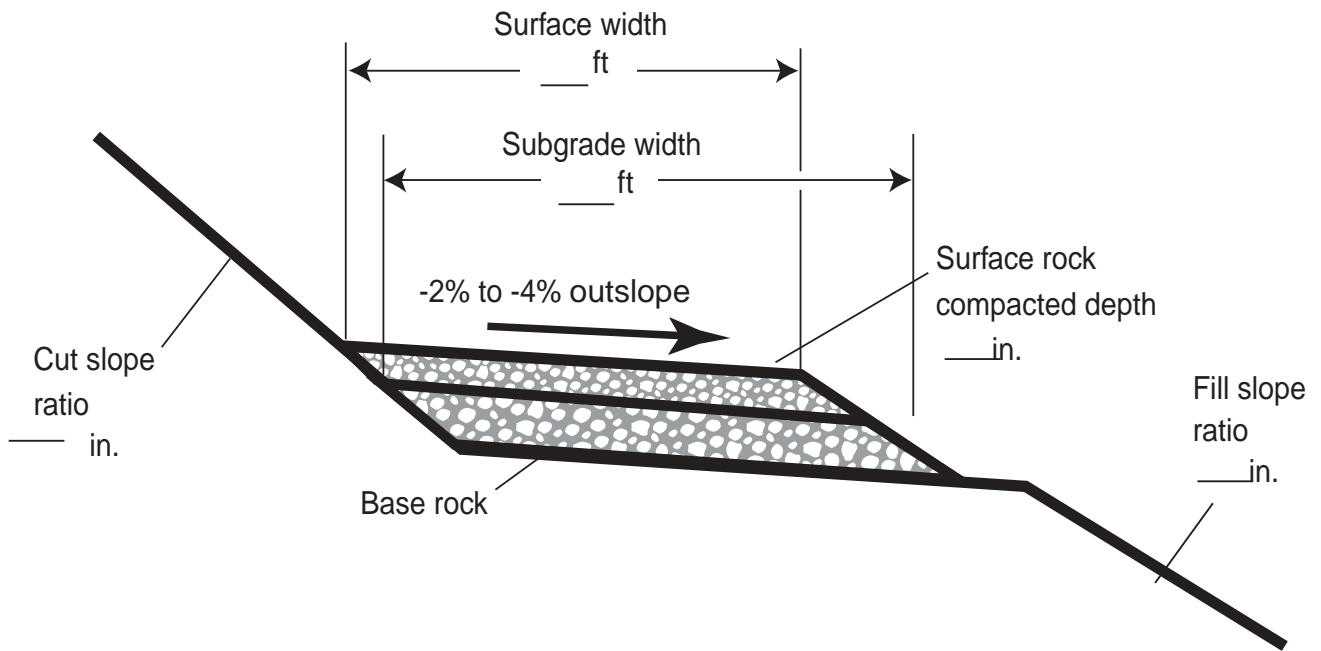
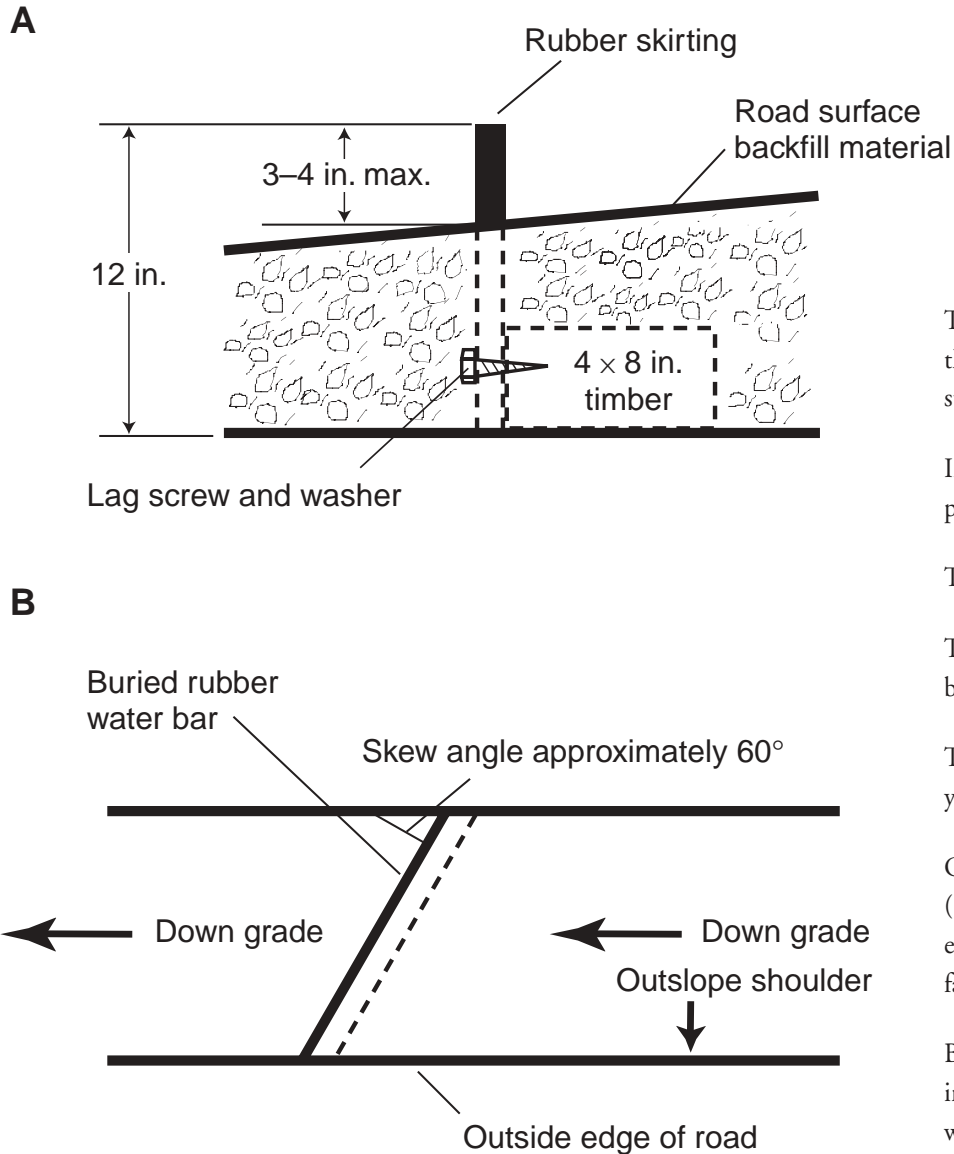

Figure A-5. Template for outsloped rock-surfaced road.

RUBBER WATER BAR



The following is a list of materials (and their specifications) used to construct a standard rubber water bar.

Industrial rubber conveyor belting: 5 ply, 12 in. by 20 ft.

Timber: 4 in. by 8 in. by 20 in.

Timber shall be rough sawed no. 2 or better.

The timber will be treated with a 20-year life preservative.

Galvanized lag screws: 3/8 in. by 2 in. (11 each) with galvanized flatfield washers to secure the belting to the narrow face of the timber.

Backfill material shall be placed in 4-in. compacted lifts around the rubber water bar.

Figure A-6. Rubber water bar specifications.

DRAIN DIP

The 210-foot total length shown in Figure A-7 assures logging truck passage without broaching. If this is not a concern (such as after a logging operation), the minimum length of a drain dip is 65 feet, where 35 feet and 30 feet replace the 110 feet and 100 feet of the sections in Figure A-7. Refer to Chapter 3, Figure 3-9, and Table 3-1.

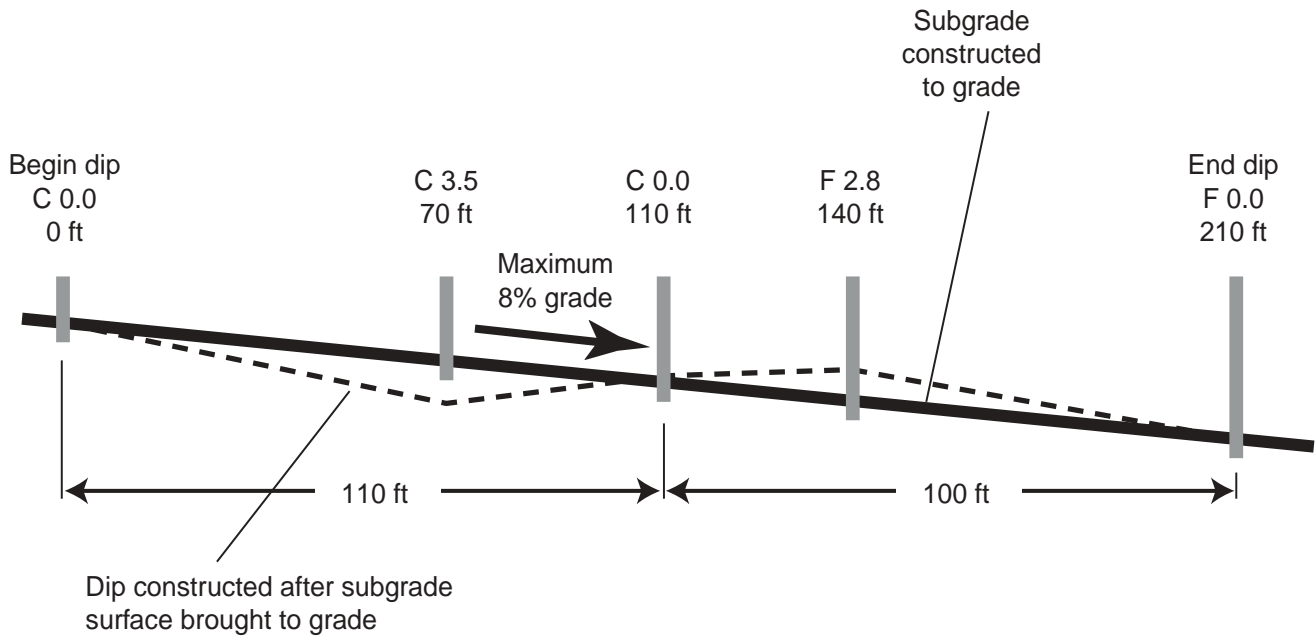
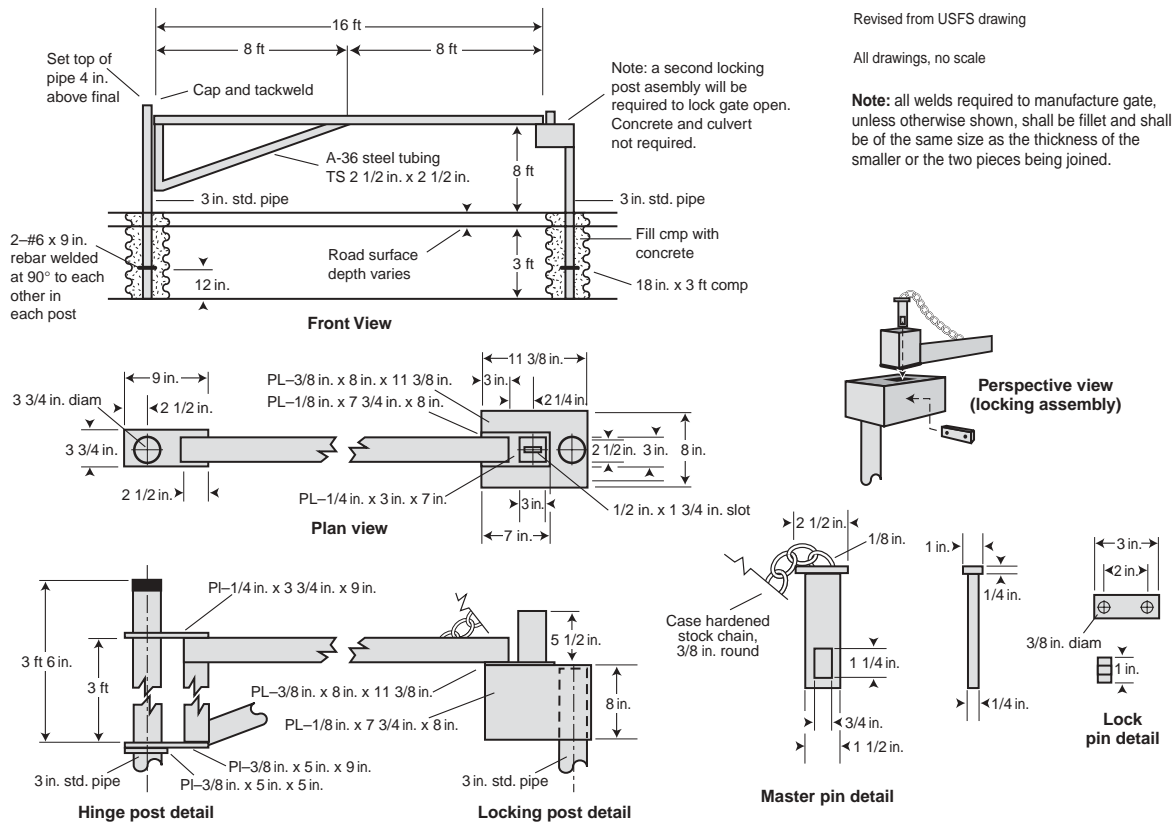

Figure A-7. Example drain dip specifications.

GATES



1. The gate shall be "Powder River" stockyard type or its equivalent. The gate frame shall be fabricated from 1 1/4 in. high strength steel tubing (50,000 PSI min yield strength) the vertical stays shall be high strength press formed 3 in. x 12 in. gauge steel (or equal) on both faces. Finish on the gate and the two gate post shall consist of at least one coat prime and one coat of dark green surface paint.
2. All bolts and lag screws shown include washers and nuts.
3. Wooden post and wooden gate rest shall be treated with penta chlorophenol with minimum net retention of 0.5 pounds per cubic foot (dry crystal).
4. Concrete shall conform to section 602-method A, B, or C
5. All steel members except lag screws, chain, gate, frame, rebar, and bolts shall be A-36.

Material list for gate		
Item	Description	Quantity
Bolt	1/2 in. dia. x 10 in.—for gate rest	1 ea
Bolts	5/16 in. dia x 2 1/2 in.—for signs	12 ea
Chain	3/16 in. proof coil chain 24 in. long	1 ea
Gate	Powder River stockyard type	1 ea
Gate posts	4 ft standard weight pipe	2 ea
Rebar	#4	4 ea
Treated post	4 in. x 4 in. x 8 ft	1 ea
Treated post	4 in. x 4 in. x 12 ft	1 ea
Concrete	Footings	3/4 cu yd
Lag screw	3/8 in. galv. 5 in. long	2 ea
Lag screw	5/16 in. galv. 3 in. long	2 ea
Fir block	2 in. x 4 in. x 8 in.—gate support	1 ea
Strap iron	2 1/2 in. x 1/4 in. x 20 in. type II sign mounting bracket	3 ea

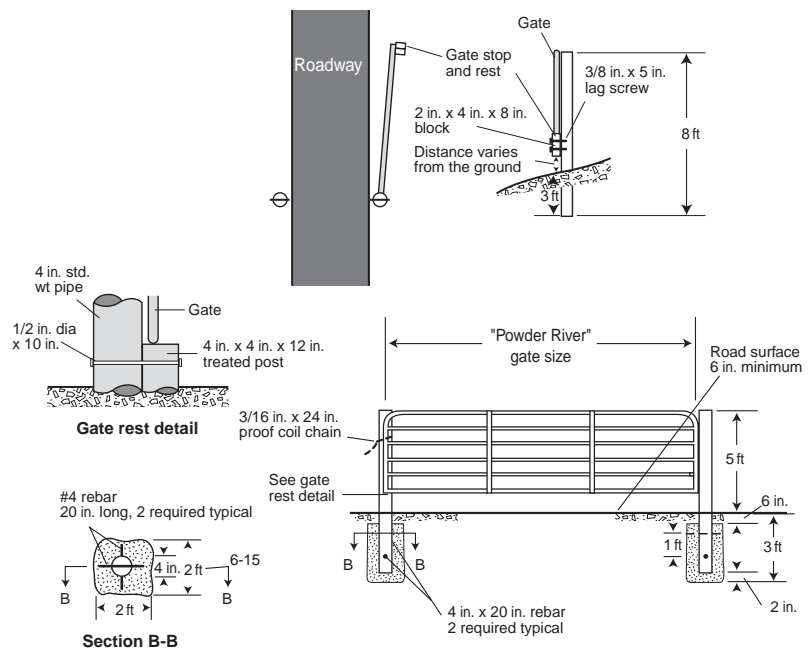

Figure A-8. Specifications for steel vehicle gate fabrication.

APPENDIX B

LICENSED FOREST ENGINEERS

The following forest engineers, licensed as Professional Engineers (P.E.s) in Oregon, offer their services to landowners in areas such as road and culvert design.

Stephen Aulerich
Forest Engineering Inc.
620 SW 4th Street
Corvallis, OR 97333
541-754-7558

Cliff Barnhart
Stuntzner Engineering & Forestry LLC
P.O. Box 167
Dallas, OR 97338
503-623-9000

Bruce Goldson
Compass Engineering
6564 SE Lake Road
Milwaukie, OR 97222
503-653-9093

Dallas Hemphill
Logging Engineering International, Inc.
1243 West 7th Ave.
Eugene, OR 97402
541-683-8383

Ken Hoffine
Lone Rock Timber Co.
P.O. Box 1127
Roseburg, OR 97470

William Knight
Knight Forest Engineering
39553 Cochran Creek Road
Brownsville, OR 97327
541-466-5458

Jerry Olson
Olson Engineering Inc.
1111 Broadway
Vancouver, WA 98660
360-695-1385

Lawson Starnes
9000 Helmick Road
Monmouth, OR 97361
541-737-6572

Dale Stennett
HCR 56 Box 511
John Day, OR 97845
541-820-3351

Ron Stuntzner
Stuntzner Engineering & Forestry, LLC
705 S. 4th St.
Coos Bay, OR 97420
541-267-2872

Eric Urstadt
Stuntzner Engineering & Forestry, LLC
3012-A Pacific Avenue
Forest Grove, OR 97116
503-357-5717

David Wellman
D. Wellman Surveying LLC
570 Lawrence St. #112
Eugene, OR 97401
541-984-1442

Greg Zartman
Logging Engineering International, Inc.
1243 West 7th Avenue
Eugene, OR 97402
541-683-8383

Compiled by Dallas Hemphill,
April 2001.

GLOSSARY

Aggregate. Mechanically crushed, angular rock used for forest road surfacing.

Balanced road section. An excavation technique used on gentle to moderate slopes where the excavated cut material is used to make the adjacent fill on a section of road. On a balanced road section, the cut material is equal to the compacted fill material.

Base course. The bottom layer of road surface rock in a two-layer surfacing system. The base course is the layer between the subgrade and the surface layer of crushed rock.

Catch point. The point at which a road cut or fill slope intercepts the natural ground.

Centerline. The established center point of a road.

Clearing. Removing standing and dead vegetation within a roadway clearing limits. This is the first step of construction on a forest road.

Clearing limits. The limits of clearing as designated on the ground.

CMP. Corrugated metal pipe, usually constructed of steel or aluminum.

Common material. Soil suitable for fill material.

Contract. See Timber sale contract.

Compaction. Mechanically compressing soil or rock, resulting in increased density in pounds per cubic foot.

Construction slash. All vegetative material not suitable for timber production, such as tops and limbs of trees, brush, and removed stumps.

Crest vertical curve. The transition between an uphill and downhill grade, an uphill to less extreme uphill grade, or a downhill to a less extreme downhill grade.

Crowned. A road surface that is sloped from the center of the road to the inside and outside road edges. This is one method of achieving road surface drainage.

Crushed rock. Rock used for road surfacing that has been mechanically crushed to a specified range of rock particle sizes.

Culvert. A drainpipe that channels water across and off a road.

Cut slope. The inside road slope cut into the face of the hill slope.

Downspout. A trough attached to a culvert outlet that carries water beyond the fill slope to control erosion.

Drain dip. A shallow depression dug across a road to facilitate road surface drainage without interrupting vehicle passage.

Duff. Accumulated surface litter on the forest floor.

Elements. The road elements are the various parts of the road, such as its base, subgrade and surface, and the cut and fill of the cross-slope above and below the road.

Embankment. Soil, aggregate, or rock material placed on a prepared ground surface and constructed to grade. The embankment is the fill material on the downhill side of the road, or, on through fill sections, the entire road.

End haul. Moving excavated roadway material a distance (usually by dump truck) to the fill site, as opposed to side-casting the cut directly onto the fill.

Energy dissipater. A structure, usually made of rock or logs, that dissipates the energy of water discharged from a culvert.

Environmental impact. An activity that has an effect on the surrounding environment, such as eroded soil from a road silting a nearby stream.

Erosion. The process of dislodging and transporting soil particles by wind, flowing water, or rain.

Excavation. Removing earth from an area.

Fifty-year flood. A flood event that has a 2% probability of occurring annually. The size of this projected flood will determine the dimensions of several components of the road built around streams, such as bridges and culverts.

Filter (or buffer) strip. A strip of land adjacent to a water body; its vegetative cover is used to filter the sediments out of surface runoff water from roads.

Fill. Earth material used to build a structure above natural ground level, as with fill sections on the downhill side of a road.

Fill slope. Areas on the downhill side of a roadway (or both sides in a through fill section) that must have excavated material placed on them to build a road section up to grade.

Grubbing. The digging and removal of stumps and roots and removal of duff within the clearing limits of the roadway.

Horizontal curve. A circular curve used to change the horizontal direction, left or right, of a road.

Inslope. A road surface sloped toward the ditched side (or the inside shoulder) of a road.

Landing. A logging site where logs are collected and/or stored.

Lift. A layer of soil or road surface rock.

Off-tracking. The distance the rear wheel sets on a log truck, tractor-trailer, or other vehicle pull to the inside on a curve. Because of off-tracking, curves will need to be wider than straight sections of road. In general, the tighter the curve, the more a vehicle will off-track.

Outslope. A road surface sloped to the outside shoulder. In general, an outsloped road needs no ditch because the slope of the road itself sheds runoff water away from the road.

Pioneer road. Temporary access roadway constructed within the clearing limits to provide for clearing, grubbing, and timber removal activities.

Pioneering. Constructing the pioneer road.

Plan (or aerial) view. An engineering term for the view of an object from above.

Prism. See Road prism.

Profile view. The side view of an object.

Raveling. The movement of soil or aggregate usually caused by erosion on cut and fill slopes.

Reconstruction. Rebuilding existing roads, beyond normal maintenance activities.

Relief culvert. A pipe that carries water from road ditches across a road, discharging beyond the fill slope.

Right-of-way. A general term denoting the privilege to pass over land in some particular line, such as a road right-of-way.

Right-of-way timber. The logs within the clearing limits of a road that are removed after trees are felled and after the construction of the pioneer road.

Road grade. The slope of a road surface in the direction of travel, usually expressed in percent (in feet per 100 feet). For example, a 10% grade equals a change along the road of 10 feet vertical in 100 feet horizontal.

Road prism. The road geometry between the extreme points of excavation and/or fill.

Road template. These are used to establish the shape and basic dimensions of a road's cross-section.

Roadbed. A road subgrade surface between the subgrade shoulders.

Roadway. The portion of a road within the limits of excavation and embankment.

Sag vertical curve. The transition between a downhill and an uphill grade, or a steeper downhill and less severe downhill grade.

Seasonal road. A road that is used mainly during a specific season, such as a logging road used only during the dry season.

Side cast. Excavation material that is pushed from a road cut to a fill area. This method is generally used only on gentler slopes and shallower fills.

Sliver fill. A horizontally narrow fill on relatively steep ground. This type of fill is often undesirable because it can fail over time. Because it is too narrow and too steep to properly compact, a sliver fill is side cast into place without compaction, which adds to its instability.

Slope ratio. The steepness of a slope expressed as a ratio of the slope's horizontal to vertical distance ratio. For example, a 1:1 slope changes 1 foot horizontal to every 1 foot vertical (45 degrees).

Slope stability. A natural or artificial slope's resistance to movement or to failure.

Slough. Material that has eroded and raveled from cut or fill slopes.

Slump. A failure of a natural or constructed slope.

Specifications. A description of the technical requirements for a material, product, or service that includes criteria for determining whether these requirements are met.

Standards. The definitive dimensions or specific materials incorporated in a road, and often set by the road contract. For example, a standard subgrade width is 12 feet.

Subgrade. The layers of roadbed on which the base or surface course are placed. On an unsurfaced road, the finished subgrade is the wearing surface (the top layer of the road's surface).

Surface course. The top layer of a road surface.

Tangent. A straight section of road between two horizontal curves.

Through cut. A roadway section cut through a ridge; it will have cut slopes above both sides of the road.

Through fill. An elevated roadway section with fill slopes below both sides of the road.

Timber sale contract. A written contract is a legal document that controls the removal of timber and other engineering work, such as road construction, location, and maintenance.

Traffic volume. The number of vehicles passing per day over a given section of road. In general, the more traffic volume, the more road surfacing needed. Often, this is not a consideration for the small landowner.

Turnout. A short auxiliary lane on a single-lane road allows meeting vehicles to pass each other. It is usually designed for ease of access for the unloaded truck so that the loaded truck can proceed.

Vertical curve. A curve that makes a transition between two road grades (such as between uphill and downhill grades). Unlike horizontal curves, which are designed as portions of a whole circle, vertical curves are designed with flatter parabolic, or non-circular, curves.

Water bar. A structure installed in the road surface to divert road surface water off of the road. Water bars are constructed from subgrade soil or other materials, such as rubber strips and timber.

Wearing surface. The road surface on which vehicle wheels run.

Oregon State University is an affirmative action equal opportunity employer.



Forestry Communications Group
Oregon State University
256 Peavy Hall
Corvallis, OR 97331-5704

Address Service Requested

Non-Profit Org.
U.S. Postage

PAID

Corvallis, OR
Permit No. 200